

Master Lock®



Commercial Security Products

T | E | C | H | N | I | C | A | L M | A | N | U | A | L

ISSUE 06.13

Electronic Update September 2013



Table of Contents

Index by Model No.	1
ProSeries® 6270 & 6271 Lock Service Procedure	2
ProSeries® Rekeyables Service Procedure	3
ProSeries® 6230 Locks Service Procedure	5
ProSeries® Rekeyables Component Parts	4,6
ProSeries® Interchangeable Core Service Procedure	7
ProSeries® Interchangeable Core Component Parts	8
ProSeries® Door Hardware Service Procedure	9
ProSeries® Door Hardware Component Parts	10
21, 24, 25, 27 and 101 Laminated Rekeyables Service Procedure	11
Python™ Cylinder Compatible Products Service Procedure	11
Cylinders and Retainers	13-17
Cylinder Service Procedure	18
Keying	19-22
Improved 6000 and 7000 Keyways	23
Keys and Keyways	24
Bitting Specifications	25
ProSeries® Actuators, Retainers and Drivers	26-27
Tools	28
Lock Lubricants	29
Terminology	30-38

Model Number Index Service Procedures and Parts

Product No.	Service Procedure	Parts	Product No.	Service Procedure	Parts	Product No.	Service Procedure	Parts	Product No.	Service Procedure	Parts
6121	3	4	6427	7	8	6836	7	8	7036	7	8
6125	3	4	6521	7	8	6840	3	4	7040	3	6
6127	3	4	6527	7	8	6841	7	8	7041	7	8
6230	5	6	6621	9	10	6842	9	10	7042	9	10
6270	2	2	6627	9	10	6850	3	6	7045	3	6
6271	2	2	6721	9	10	6851	7	8	7046	7	8
6321	3	4	6727	9	10	6852	9	10	7047	9	10
6325	3	4	6830	3	4	7030	3	6	7050	3	6
6327	3	4	6831	7	8	7031	7	8	7051	7	8
6421	7	8	6835	3	6	7035	3	6	7052	9	10

Master Lock introduced the **ProSeries®** product line in 1992 with Weather Tough® and High Security, iron shrouded, rekeyable padlocks. Intent on providing locksmiths with greater ease and flexibility, Master Lock designed the padlocks to use standard components across the line. Since then, **ProSeries®** has grown to include solid body padlocks in Brass, Steel and Aluminum to further satisfy corrosion, security and safety requirements. Master Lock has also added extensive interchangeable core and door hardware cylinder options to create maximum options for padlock integration into facility padlock and door lock systems. Today, **ProSeries®** is the only product line available for so many different applications, making Master Lock the source for complete commercial security.

ProSeries® 6270 & 6271 Locks Service Procedure

The 6270 is a solid steel body lock. The 6271 is a zinc die cast body lock. Disassembling for servicing these two locks may be accomplished by following the steps listed below (refer to the diagram at the right for parts and orientation).

- Loosen or remove the cylinder mounting screw, H, on the back of the lock body with a 3/32" hex wrench. (Early production used 2.5mm)
- Use the key to unlock the shackle. (If key is unavailable you will have to use another method to unlock the shackle).
- Pull on the cylinder to remove it.
- For rekeying, loosen set screw, J, (1.5 mm), inside the last pin chamber to allow 180° rotation of the plug.
- Align pin chambers in plug with service holes in the bottom of the shell to remove existing bottom pins and replace with new combination.
- Rotate plug to key pull position and tighten the set screw in the last pin chamber.

The order may be reversed to reassemble the lock.

These locks are available with the K6000 and K7000 key. They are also available with the EDGE™ System keyways WP4 and WP6. By specifying the 600A and 700A keyways they can also be supplied as compatible with American Lock products in the field.

Identification Code	Description	Part Number
A & C	Stock Master 6 pin cylinder. Includes zero bitted cylinder with shackle and two key blanks.	297W7000KZ
	Optional Master 5 pin cylinder. Includes zero bitted cylinder with shackle and two key blanks.	297W6000KZ
	Optional American 6 pin W700A cylinder. Includes zero bitted cylinder with shackle and two key blanks.	297W700AKZ
	Optional American 5 pin W600A cylinder. Includes zero bitted cylinder with shackle and two key blanks.	297W600AKZ
	Optional EDGE™ System 6 pin cylinder. Includes zero bitted cylinder with shackle but no blanks	297WP6UN
	Optional EDGE™ System 4 pin cylinder. Includes zero bitted cylinder with shackle but no blanks	297WP4UN
H	Hex Screw (uses 3/32" hex wrench)	6270-0400 (Contains 6 screws)
J	Hex Screw (uses 1.5mm hex wrench)	6270-0401 (Contains 6 screws)

These locks are NRK (Non Removable Key) function. Key can only be removed if shackle is locked. Because of the lock design, the shackle may be locked open or locked closed via this function.

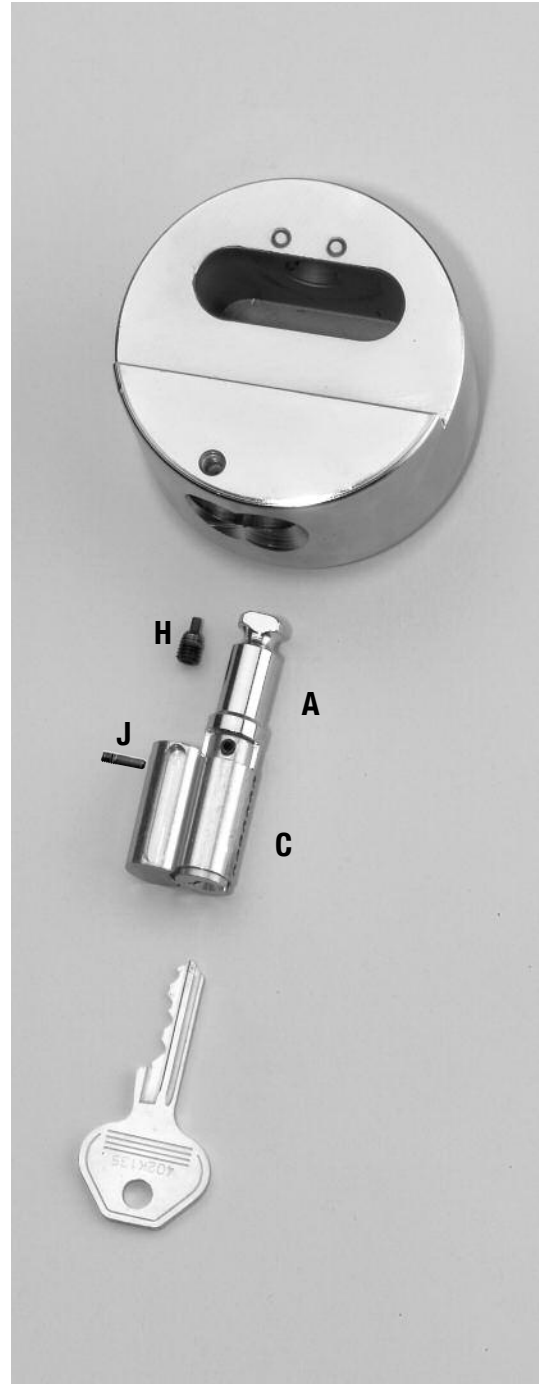

ProSeries® Rekeyables Service Procedure

6121, 6125, 6127, 6321, 6325, 6327, 6830, 6835, 6840, 6850, 7030, 7035, 7040, 7045, 7050 Series

All of the ProSeries® locks have a generic construction technology that allows for a uniform assembly and disassembly technique. Below is a step-by-step procedure for disassembling one of these padlocks (refer to diagram at right for parts and orientation). The only exceptions to this procedure will be the Door Hardware and IC versions of the lock.

- Use the key to unlock the shackle, A. (If the key is unavailable you will have to use another method to unlock the shackle).
- Use a 7/64" hexagonal wrench to remove the mounting screw located inside the toe side shackle hole.
- Holding the trap door, D, in place, lock the shackle, A, into the padlock body. (This relieves pressure on the actuator, E).
- Remove the trap door, D, and the nut, F.
- Remove the cylinder, C.
- Remove the actuator, E.
- Remove the locking ball bearings, B, and shackle, A.

The order may be reversed to reassemble the lock. A light application of assembly grease may be used to hold the ball bearings in place during assembly.

If the lock only needs to be rekeyed, it is not necessary to remove the actuator, ball bearings, or shackle.

Two functions are available in the locks, NKR (Non Key Retaining) and NRK (Non Removable Key) and both functions are accomplished as a design feature of the actuator.

The NKR, non key retaining, function actuator used in the lock has a projection on one side. You should note the orientation of this projection when removing the actuator so that you can easily reinstall it during the reassembly process. Actuators are supplied with different sizes and two different styles have been used in the ProSeries® locks. Consult the Actuator section, page 26, of this manual for more detailed information.

The NRK, non removable key, function actuator does not have a projection to help with orientation and you will have to rely on the position of the half-moon shaped actuator the tail of the cylinder contacts. Again, different sizes and styles are available for use in the ProSeries® locks, so consult the Actuator section, page 26, of this manual for more detailed information.

See component parts list on page 4 and 6.



ProSeries® Rekeyables Component Parts

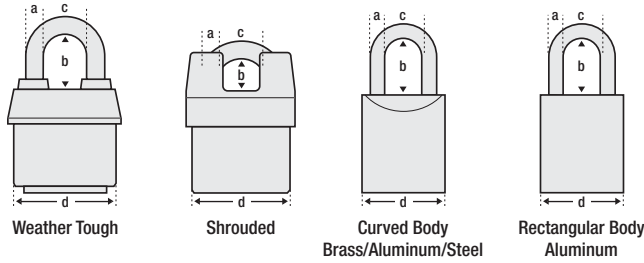

	Model #	Vertical Shackle Clearance (b)	Components							
			Shackle	Ball Bearings	Cylinder	Trap Door	Actuator		Flared Nut	Screw
			A	B	C	D	NKR*	NRK**	F	G
Weather Tough®	2-1/8" Wide Laminated Steel Body. Shackle Dimensions: a: 5/16" c: 7/8"									
	6121	1-1/8"	293S6121	6121-0427	See List Page 18	6121-0420	6121-0423	6121-0424	6121-0421	6121-0422
	6121LF	1-1/2"	293LF6121							
	6121LJ	2-3/8"	293LJS6121							
	6121LN	5-3/4"	293LNS6121							
	2-3/8" Wide Laminated Steel Body. Shackle Dimensions: a: 3/8" c: 7/8"									
	6125	1-3/8"	293S6125	6121-0427	See List, P. 18	6121-0420	6121-0423	6121-0424	6121-0421	6121-0422
	6125LJ	2-3/8"	293LJS6125							
	2-5/8" Wide Laminated Steel Body. Shackle Dimensions: a: 7/16" c: 7/8"									
6127	1-3/8"	293S6127	6121-0427	See List Page 18	6121-0420	6121-0423	6121-0424	6121-0421	6121-0422	
6127LH	1-7/8"	293LHS6127								
6127LJ	2-3/8"	293LJS6127								
Iron Shroud	2-1/8" Wide Laminated Steel Body. Shackle Dimensions: a: 5/16" c: 7/8"									
	6321	3/4"	293S6321	6121-0427	See List, P. 18	6121-0420	6121-0423	6121-0424	6121-0421	6121-0422
	2-3/8" Wide Laminated Steel Body. Shackle Dimensions: a: 3/8" c: 7/8"									
	6325	3/4"	293S6325	6121-0427	See List, P. 18	6121-0420	6121-0423	6121-0424	6121-0421	6121-0422
2-5/8" Wide Laminated Steel Body. Shackle Dimensions: a: 7/16" c: 7/8"										
6327	3/4"	293S6327	6121-0427	See List, P. 18	6121-0420	6121-0423	6121-0424	6121-0421	6121-0422	
Solid Brass	1-9/16" Wide Solid Brass Body. Shackle Dimensions: a: 1/4" c: 25/32"									
	6830	1-1/16"	293S6830	0220-0302	See List Page 18	6830-0420	6831-0421	6831-0422	6121-0421	6121-0422
	6830B	1-1/16"	293B6830							
	6830LF	1-9/16"	293LFS6830							
	6830LT	3"	293LTS6830							
	1-3/4" Wide Solid Brass Body. Shackle Dimensions: a: 5/16" c: 29/32"									
	6840	1-3/16"	293S6121	6121-0427	See List Page 18	6121-0420	6841-0421	6121-0424	6121-0421	6121-0422
	6840B	1-3/16"	293B6840							
	6840LF	1-9/16"	293LFS6121							
	6840LJ	2-7/16"	293LJS6121							
6840BLJ	2-7/16"	293LJB6840								
6840LN	5-3/4"	293LNS6121								

* NKR **N**on **K**ey **R**etaining. Key can be removed anytime.

NRK **Non **R**emovable **K**ey. Key can only be removed if shackle is in locked position.

ProSeries® 6230 Locks Service Procedure

The 6230 is a solid steel body lock using the ProSeries® standard ball bearing locking mechanism. Disassembling for servicing is similar to the rekeyables and may be accomplished by following the steps listed below (refer to diagram at right for parts and orientation).

- Use the key to unlock the shackle, A. (If the key is unavailable you will have to use another method to unlock the shackle).
- Use a 7/64" hexagonal wrench to remove the mounting screw located inside the toe side shackle hole.
- Holding the trap door, D, in place, lock the shackle, A, into the padlock body. (This relieves pressure on the actuator.)
- Remove the trap door, D, and the nut, F.
- Remove the cylinder, C.
- Remove the actuator, E.
- Remove the locking ball bearings, B, and shackle, A.

The order may be reversed to reassemble the lock. A light application of assembly grease may be used to hold the ball bearings in place during assembly.

If the lock only needs to be rekeyed, it is not necessary to remove the actuator, ball bearings, or shackle.

Two functions are available in the locks, NKR (Non Key Retaining) and NRK (Non Removable Key) and both functions are accomplished as a design feature of the actuator.

The NKR, non key retaining, function actuator used in the lock has a projection on one side. You should note the orientation of this projection when removing the actuator so that you can easily reinstall it during the reassembly process.

The NRK, non removable key, function actuator does not have a projection to help with orientation and you will have to rely on the position of the half-moon shaped actuator that the tail of the cylinder contacts.

See component parts list on page 6.



ProSeries® Rekeyables Component Parts

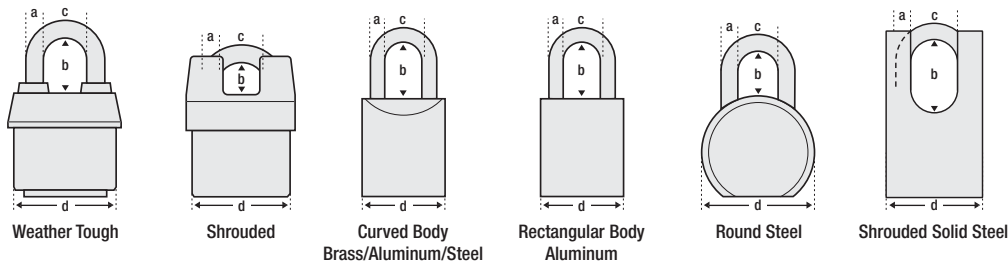

	Model #	Vertical Shackle Clearance (b)	Components							
			Shackle	Ball Bearings	Cylinder	Trap Door	Actuator		Flared Nut	Screw
			A	B	C	D	NKR*	NRK**	F	G
Solid Brass	2" Wide Solid Brass Body, Shackle Dimensions: a: 3/8" c: 29/32"									
	6850	1-1/2"	293S6125	6121-0427	See List Page 18	6121-0420	6841-0421	6121-0424	6121-0421	6121-0422
	6850B	1-1/2"	293B6850							
	6850LJ	2-1/2"	293LJS6125							
6850BLJ	2-1/2"	293LJB6850								
Solid Aluminum Body Curved	1-9/16" Wide High Visibility Aluminum Body, Shackle Dimensions: a: 1/4" c: 25/32"									
	6835	1-1/16"	293S6830	0220-0302	See List Page 18	6830-0420	6831-0421	6830-0422	6121-0421	6121-0422
	6835LF	1-9/16"	293LFS6830							
	6835LT	3"	293LTS6830							
1-1/2" Wide High Visibility Aluminum Body, Shackle Dimensions: a: 1/4" c: 3/4"										
Solid Aluminum Body Rectangular	6835	1"	APKG1582980	APKG1806010	See List Page 18	"A" Style† APKG4680210	APKG0001669	APKG0001670	APKG4746010	APKG4761010
	6835LF	1-1/2"	APKG1583180							
	6835LT	3"	APKG1583210							
	6835B	1"	APKG1583240							
Solid Steel	1-9/16" Wide Solid Steel Body, Shackle Dimensions: a: 1/4" c: 25/32"									
	7030	1-1/16"	293S6830	0220-0302	See List Page 18	6830-0420	6831-0421	6830-0422	6121-0421	6121-0422
	7030LF	1-9/16"	293LFS6830							
	7030LT	3"	293LTS6830							
	1-3/4" Wide Solid Steel Body, Shackle Dimensions: a: 5/16" c: 29/32"									
	7040	1-3/16"	293S6121	6121-0427	See List Page 18	6121-0420	6841-0421	6121-0424	6121-0421	6121-0422
	7040LF	1-9/16"	293LF6121							
	7040LJ	2-1/2"	293LJS6121							
	7040LN	5-5/8"	293LN6121							
	2" Wide Solid Steel Body, Shackle Dimensions: a: 3/8" c: 29/32"									
	7050	1-1/2"	293S6125	6121-0427	See List Page 18	6121-0420	6841-0421	6121-0424	6121-0421	6121-0422
	7050LJ	2-1/2"	293LJS6125							
	2-1/2" Wide Round Solid Steel Body, Shackle Dimensions: a: 7/16" c: 7/8"									
6230	1-1/8"	293S6230	6121-0427	See List Page 18	6121-0420	6121-0425	6121-0426	6121-0421	6121-0422	
6230LH	2"	293LHS6230								
Shrouded Solid Steel	1-9/16" Wide Solid Steel Body, Shackle Dimensions: a: 1/4" c: 25/32"									
	7035	1-1/16"	293S6830		See List, P. 18	6830-0420	6831-0421	6830-0422	6121-0421	6121-0422
	1-3/4" Wide Solid Steel Body, Shackle Dimensions: a: 5/16" c: 29/32"									
7045	1-3/16"	293S6121		Page 18	6121-0420	6841-0421	6121-0424	6121-0421	6121-0422	

Note: the 296W6000 cylinder is pinned with only 5 pins, for 6 pins order 296W7000

* NKR **Non Key Retaining**. Key can be removed anytime.

** NRK **Non Removable Key**. Key can only be removed if shackle is in locked position.

† "A" Style: For keyways W2K, W17, W81, W81KM, W417, W427, W481, W600A, W700A

†† "K" Style: For keyways W1, W1RSV, W15, W81RSV, W400, W401, W410, W6000, W7000, WP4, WP6

ProSeries® Interchangeable Core Service Procedure

6421, 6427, 6521, 6527, 6831, 6836, 6841, 6851, 7031, 7036, 7041, 7046, 7051 Series

The ProSeries® Interchangeable Core locks employ a construction technology similar to that used in the Rekeyables. It also allows for a uniform assembly and disassembly technique. Below is the step by step procedure for disassembling this version of padlock (refer to diagram at right for parts and orientation). The only exceptions to this procedure will be the Rekeyables and Door Hardware versions of the lock.

- Use the control key to remove the IC cylinder, C. (If key is unavailable you will have to use another method).
- Remove the ring retainer.
- Remove the steel retainer plate.
- Remove the throw member.
- Remove the actuator, E.
- Remove the locking ball bearings, B, and shackle, A.

The order may be reversed to reassemble the lock. A light application of assembly grease may be used to hold the ball bearings in place during assembly.

If the lock only needs to be rekeyed, it is not necessary to remove the ring retainer, retainer plate, actuator, ball bearings, or shackle.

Two functions are available in the locks, NKR (Non Key Retaining) and NRK (Non Removable Key) and both functions are accomplished as a design feature of the actuator.

The NKR, non key retaining, function actuator used in the lock has a projection on one side. You should note the orientation of this projection when removing the actuator so that you can easily reinstall it during the reassembly process. Actuators are supplied with different sizes and orientations, and two different styles have been used in the ProSeries® locks. Consult the Actuator section, page 26, of this manual for more detailed information.

The NRK, non removable key, function actuator does not have a projection to help with orientation and you will have to rely on the position of the half-moon shaped actuator the tail of the cylinder contacts. Again, different sizes and styles are available for use in the ProSeries® locks, so consult the Actuator section, page 26, of this manual for more detailed information.

See component parts list on page 8.

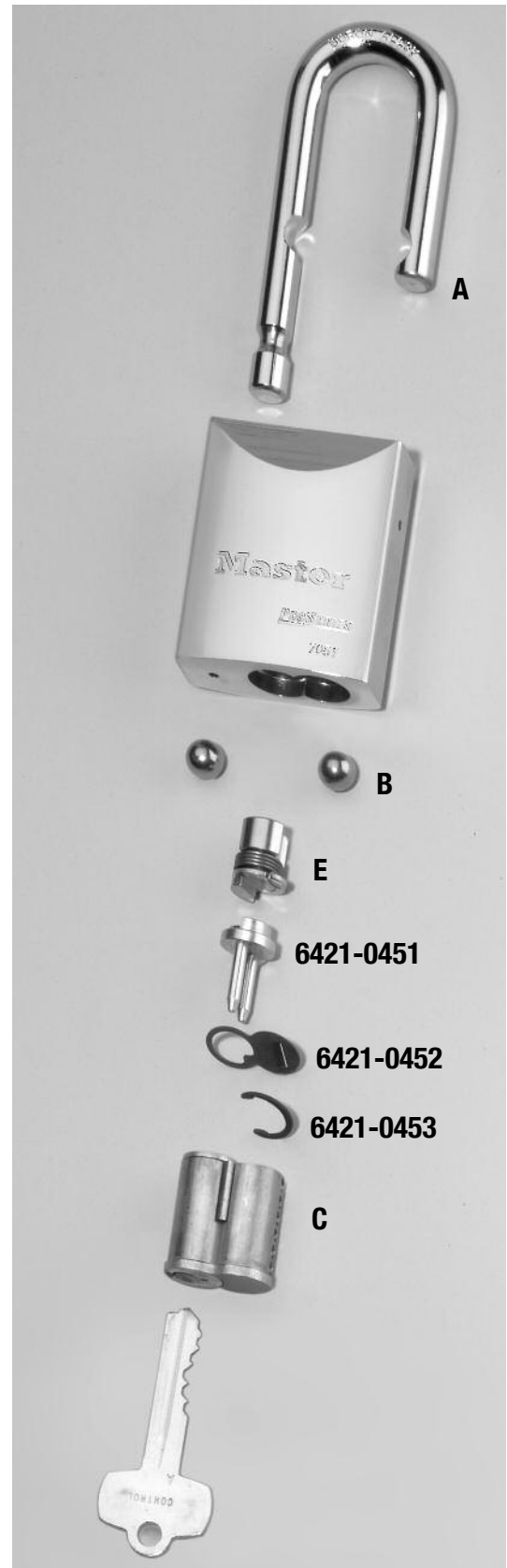

ProSeries® Interchangeable Core Component Parts

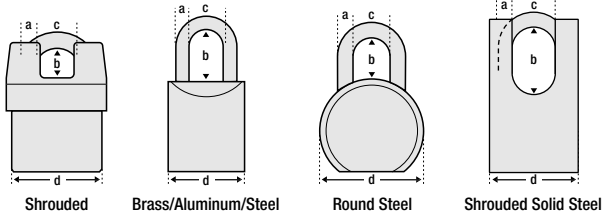

	Model #	Vertical Shackle Clearance (b)	Components							
			Shackle	Ball Bearings	Cylinder	Trap Door	Actuator		Flared Nut	Screw
			A	B	C	D	NRK*	NRK**	F	G
Weather Tough®	2-1/8" Wide Laminated Steel Body. Shackle Dimensions: a: 5/16" c: 7/8"									
	6421	1-1/8"	293S6121	6121-0427	See List P.14	N/A	6121-0423	6121-0424	N/A	N/A
	6421LF	1-1/2"	293LF6121							
	6421LJ	2-3/8"	293LJS6121							
	6421LN	5-3/4"	293LN6121							
	2-5/8" Wide Laminated Steel Body. Shackle Dimensions: a: 7/16" c: 7/8"									
	6427	1-3/8"	293S6127	6121-0427	See List P.14	N/A	6121-0423	6121-0424	N/A	N/A
	6427LH	1-7/8"	293LHS6127							
6427LJ	2-3/8"	293LJ6127								
6427LN	5-3/4"	293LN6127								
Iron Shroud	2-1/8" Wide Laminated Steel Body. Shackle Dimensions: a: 5/16" c: 7/8"									
	6521	3/4"	293S6321	6121-0427	See List P.14	N/A	6121-0423	6121-0424	N/A	N/A
	2-5/8" Wide Laminated Steel Body. Shackle Dimensions: a: 7/16" c: 7/8"									
	6527	3/4"	293S6327	6121-0427	See List P.14	N/A	6121-0423	6121-0424	N/A	N/A
Solid Brass	1-9/16" Wide Solid Brass Body. Shackle Dimensions: a: 1/4" c: 25/32"									
	6831	1-1/16"	293S6830	0220-0302	See List P.14	N/A	6831-0421	6830-0422	N/A	N/A
	6831B	1-1/16"	293B6830							
	6831LF	1-9/16"	293LFS6830							
	6831BLF	1-9/16"	293LFB6830							
	1-3/4" Wide Solid Brass Body. Shackle Dimensions: a: 5/16" c: 29/32"									
	6841	1-3/16"	293S6121	6121-0427	See List P.14	N/A	6841-0421	6121-0424	N/A	N/A
	6841B	1-3/16"	293B6840							
	6841LF	1-1/2"	293LFS6121							
	6841LJ	2-7/16"	293LJS6121							
	6841BLJ	2-7/16"	293LJB6840							
	2" Wide Solid Brass Body. Shackle Dimensions: a: 3/8" c: 29/32"									
	6851	1-1/2"	293S6125	6121-0427	See List P.14	N/A	6841-0421	6121-0424	N/A	N/A
6851B	1-1/2"	293B6850								
6851LJ	2-1/2"	293LJ6125								
6851BLJ	2-1/2"	293LJB6850								
Solid Aluminum	1-9/16" Wide High Visibility Aluminum Body. Shackle Dimensions: a: 1/4" c: 25/32"									
	6836RED	1-1/16"	293S6830	0220-0302	See List P.14	N/A	6831-0421	6830-0422	N/A	N/A
	6836LFRED	1-9/16"	293LFS6830							
	6836LTRED	3"	293LTS6830							
	6836ORJ	1-1/16"	293S6830							
	6836LFORJ	1-9/16"	293LFS6830							
	6836LTORJ	3"	293LTS6830							
	6836YLW	1-1/16"	293S6830							
	6836LFYLW	1-9/16"	293LFS6830							
	6836LTYLW	3"	293LTS6830							
	6836GRN	1-1/16"	293S6830							
	6836LFGRN	1-9/16"	293LFS6830							
	6836LTGRN	3"	293LTS6830							
	6836BLU	1-1/16"	293S6830							
	6836LFBLU	1-9/16"	293LFS6830							
	6836LTBLU	3"	293LTS6830							
	6836BLK	1-1/16"	293S6830							
	6836LFBLK	1-9/16"	293LFS6830							
6836LTBLK	3"	293LTS6830								
Solid Steel	1-9/16" Wide Solid Steel Body. Shackle Dimensions: a: 1/4" c: 25/32"									
	7031	1-1/16"	293S6830	0220-0302	See List P.14	N/A	6831-0421	6830-0422	N/A	N/A
	7031LF	1-9/16"	293LFS6830							
	7031LT	3"	293LTS6830							
	1-3/4" Wide Solid Steel Body. Shackle Dimensions: a: 5/16" c: 29/32"									
	7041	1-3/16"	293S6121	6121-0427	See List P.14	N/A	6841-0421	6121-0424	N/A	N/A
	7041LJ	2-1/2"	293LJS6121							
	2" Wide Solid Steel Body. Shackle Dimensions: a: 3/8" c: 29/32"									
7051	1-1/2"	293S6125	6121-0427	See List P.14	N/A	6841-0421	6121-0424	N/A	N/A	
7051LJ	2-1/2"	293LJS6125								
Shrouded Solid Steel	1-9/16" Wide Solid Steel Body. Shackle Dimensions: a: 1/4" c: 25/32"									
	7036	1-1/16"	293S6830	0220-0302	See List P.14	N/A	6831-0421	6830-0422	N/A	N/A
1-3/4" Wide Solid Steel Body. Shackle Dimensions: a: 5/16" c: 29/32"										
7046	1-3/16"	293S6121	6121-0427	See List P.14	N/A	6841-0421	6121-0424	N/A	N/A	

* NRK Non Key Retaining. Key can be removed anytime.

**NRK Non Removable Key. Key can only be removed if shackle is in locked position.

ProSeries® Door Hardware Service Procedure

6621, 6627, 6721, 6727, 6842, 6852, 7042, 7047, 7052 Series

The ProSeries® Door Hardware locks employ a construction technology similar to that used in the Rekeyables. It also allows for a uniform assembly and disassembly technique. Below is the step by step procedure for disassembling this version of padlock. The only exception to this procedure will be the IC version of the lock.

- Use the key to unlock the shackle, A. (If key is unavailable you will have to use another method to unlock the shackle).
- Use a 7/64" hexagonal wrench to remove the mounting screw located inside the toe side shackle hole.
- Holding the plug retainer, D, in place, lock the shackle, A, into the padlock body. (This relieves pressure on the actuator.)
- Remove the cylinder driver, K, with the cylinder, C.
- Remove the driver if it did not come out with the cylinder adapter and the cylinder.
- Remove the actuator, E.
- Remove the locking ball bearings, B, and shackle, A.

The order may be reversed to reassemble the lock. A light application of assembly grease may be used to hold the ball bearings in place during assembly.

If the lock only needs to be rekeyed, it is not necessary to remove the actuator, ball bearings, or shackle.

Two functions are available in the locks, NKR (Non Key Retaining) and NRK (Non Removable Key) and both functions are accomplished as a design feature of the actuator.

The NKR, non key retaining, function actuator used in the lock has a projection on one side. You should note the orientation of this projection when removing the actuator so that you can easily reinstall it during the reassembly process. Actuators are supplied with different sizes and two different styles have been used in the ProSeries® locks. Consult the Actuator section, page 26, of this manual for more detailed information.

The NRK non removable key, function actuator does not have a projection to help with orientation and you will have to rely on the position of the half-moon shaped actuator the tail of the cylinder contacts. Again, different sizes and styles are available for use in the ProSeries® locks, so consult the Actuator section, page 26, of this manual for more detailed information.

See component parts list on page 10.

Door Hardware Cylinder Drivers (K), page 26, 27.

Lori	298-0626
Medeco	298-0627
Schlage	298-0628
Lockwood (Australia)	298-0625

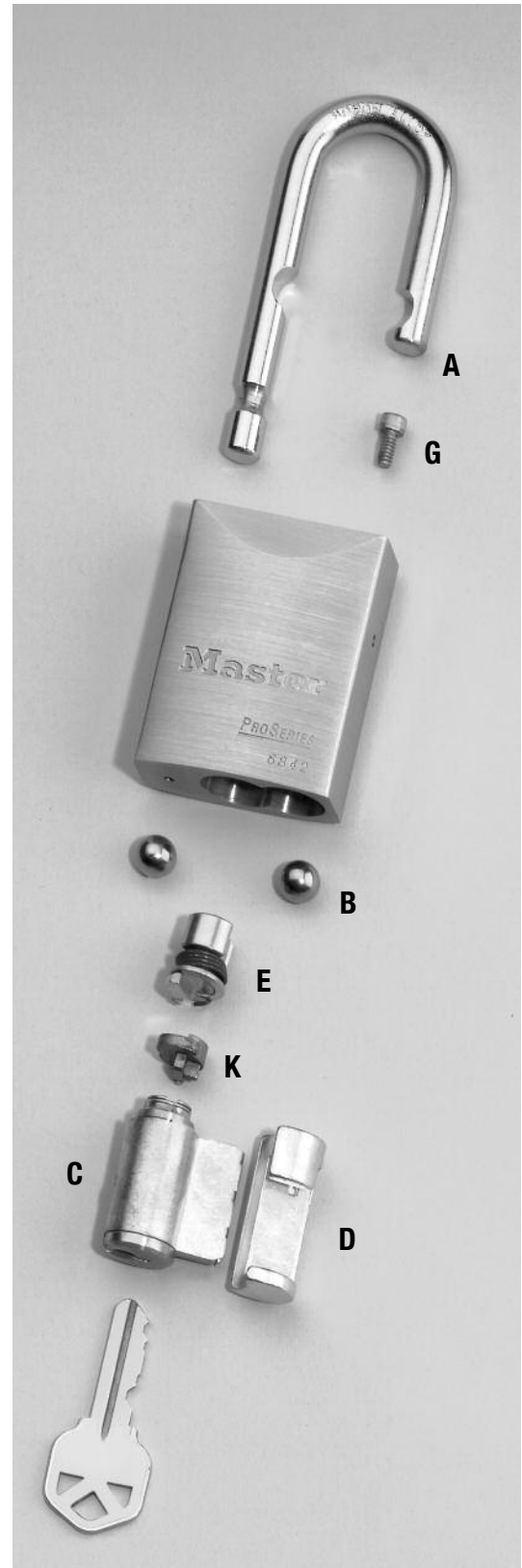

ProSeries® Door Hardware Component Parts

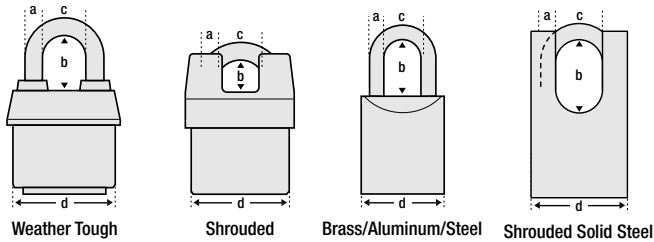

	Model #	Vertical Shackle Clearance (b)	Components							
			Shackle	Ball Bearings	Cylinder	Retainer	Actuator		Flared Nut	Screw
			A	B	C	D	NKR*	NRK**	F	G
Weather Tough®	2-1/8" Wide Laminated Steel Body. Shackle Dimensions: a: 5/16" c: 7/8"									
	6621	1-1/8"	293S6121	6121-0427	See List P.15	298-0629	6121-0423	6121-0424	N/A	6621-0450
	6621LF	1-1/2"	293LF6121							
	6621LJ	2-3/8"	293LJS6121							
	6621LN	5-3/4"	293LN6121							
	2-5/8" Wide Laminated Steel Body. Shackle Dimensions: a: 7/16" c: 7/8"									
	6627	1-3/8"	293S6127	6121-0427	See List P.15	298-0629	6121-0423	6121-0424	N/A	6621-0450
6627LH	1-7/8"	293LHS6127								
6627LJ	2-3/8"	293LJ6127								
6627LN	5-3/4"	293LN6127								
Iron Shrouded	2-1/8" Wide Laminated Steel Body. Shackle Dimensions: a: 5/16" c: 7/8"									
	6721	3/4"	293S6321	6121-0427	See List P.15	298-0629	6121-0423	6121-0424	N/A	6621-0450
	2-5/8" Wide Laminated Steel Body. Shackle Dimensions: a: 7/16" c: 7/8"									
6727	3/4"	293S6327	6121-0427	See List P.15	298-0629	6121-0423	6121-0424	N/A	6621-0450	
Solid Brass	1-3/4" Wide Solid Brass Body. Shackle Dimensions: a: 5/16" c: 29/32"									
	6842	1-3/16"	293S6121	6121-0427	See List P.15	298-0629	6841-0421	6121-0424	N/A	6621-0450
	6842B	1-3/16"	293B6840							
	6842LF	1-1/2"	293LFS6121							
	6842LJ	2-1/2"	293LJS6121							
	6842BLJ	2-1/2"	293LJB6840							
	2" Wide Solid Brass Body. Shackle Dimensions: a: 3/8" c: 29/32"									
	6852	1-1/2"	293S6125	6121-0427	See List P.15	298-0629	6841-0421	6121-0424	N/A	6621-0450
	6852B	1-1/2"	293B6850							
	6852LJ	2-1/2"	293LJS6125							
6852BLJ	2-1/2"	293LJB6850								
Solid Steel	1-3/4" Wide Solid Steel Body. Shackle Dimensions: a: 5/16" c: 29/32"									
	7042	1-3/16"	293S6121	6121-0427	See List P.15	298-0629	† 6121-0423	6121-0424	N/A	6621-0450
	7042LJ	2-1/2"	293LJS6121							
	2" Wide Solid Steel Body. Shackle Dimensions: a: 3/8" c: 29/32"									
7052	1-1/2"	293S6125	6121-0427	See List P.15	298-0629	† 6121-0423	6121-0424	N/A	6621-0450	
7052LJ	2-1/2"	293LJ6125								
Shrouded Solid Steel	1-3/4" Wide Solid Steel Body. Shackle Dimensions: a: 5/16" c: 29/32"									
	7047	1-3/16"	293S6121	6121-0427	See List. P.15	298-0629	† 6121-0423	6121-0424	N/A	6621-0450

* NKR **Non Key Retaining**. Key can be removed anytime.

NRK **Non Removable Key. Key can only be removed if shackle is in locked position.

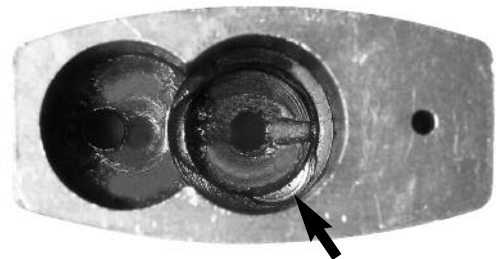

† Check milling in lock to use 6121-0423.

Laminated Rekeyable Service Procedure

Padlock model numbers 21, 24, 25, 27 and 101 are laminated steel padlocks that have a trap door you can remove so that the cylinder may be exchanged or rekeyed. The model 24 has a laminated brass plate body.

Cylinder Replacement Instructions

- Unlock padlock. Withdraw key.
- Turn shackle away from opening.
- Insert hex wrench into shackle opening to engage socket screw.
- Lift out retainer plate. Tip padlock to slide cylinder out.

To install new cylinder, insert protruding end first. Re-assemble by reversing above three steps.

NOTE: When using “WO” versions of the No. 21, 24, 25, 27 or 101 padlock, use a screwdriver initially to open shackle. Insert tip through opening in bottom plate. Turn mechanism as shown to trip shackle release.

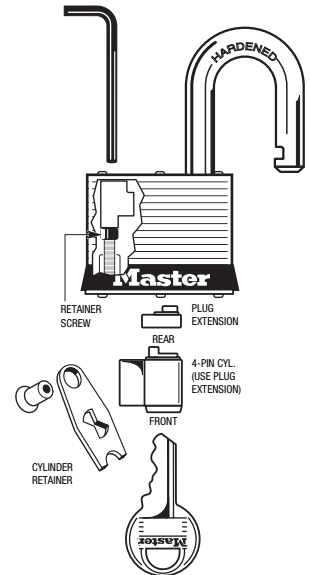
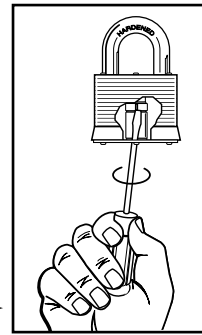

All laminated padlock bodies may be ordered without shackles installed to allow you to stock the different length shackles and thereby reduce your inventory investment. Once a shackle has been installed and the kick plate hammered in place the shackle cannot be changed.

Python™ Compatible Products Service Procedure

REKEYABLE COUPLER LOCKS 34, 35, 37 & 39

The new rekeyable versions of the coupler locks may be identified by their dark gray or black color and have in them a Python™ cylinder that can be rekeyed using the 8491 keying kit following the instructions on page 21 of this manual. As with all Python™ cylinder products, use the removal tool when in the unlocked position to pull the plug from the lock body. If you don't have the removal tool, a hook pick can be used to retract the retainer tumbler at the back of the keyway.



379ATPY UNIVERSAL COUPLER LOCK

Two versions of the number 379 lock are available. Only the commercial version is rekeyable. The retail version is part number 379DAT, has a chrome finish and is not rekeyable. The commercial version has the same dark gray or black finish as the 34, 35, 37 & 39 models above and has the part number 379ATPY.

The cylinder plug in the 379ATPY uses the Python™ cylinder mechanism but the plug cannot be interchanged with other Python™ cylinders. As shown here, it has a rod like projection from the rear of the plug. Spare plugs may be ordered using part number 8401-0340.



Python™ Compatible Products Service Procedure *continued*



It can be rekeyed using our 8491 Python™ keying kit and can be removed from the lock body with the standard Python™ plug removal tool. With the plug in the unlocked position fully insert the removal tool and then pull on the tool. If the plug doesn't come out immediately, wiggle the tool and then pull, the plug should be released and come out on the end of the tool.

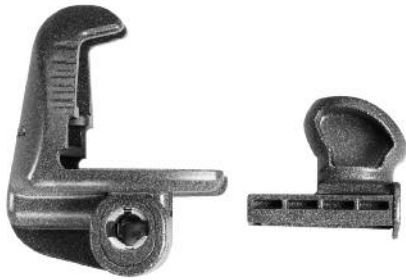

In order to install the plug back into the housing some further disassembly is required.

At the far end of the plug there is a locking member with a square recess in it. Use a small screwdriver to push this locking member down and disengage it from the sliding bolt of the lock.

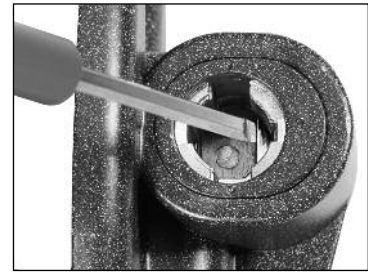

With the locking member pushed down, the sliding bolt can be removed from the lock completely. While holding the locking member down, use a finger to hold it in place from the top while reinserting the plug. The plug should have the removal tool in it and the rod extending from the back toward the bottom of the lock when inserted.

As you can see here, the locking member is spring loaded and can jump out of position. Reinstalling it without distorting the spring takes a little patience and a pair of needle nose pliers.

If you remove the locking member from the lock body you must reinsert it with the opening up and then, when over the recess for it in the body, pivot the locking member so the opening faces the rear as shown here.

All keys for Python Mechanism products are the type with a plastic cover on the head of the key. If you need code information, you can typically find it stamped on the key head under the cover.

These are standard Master Lock key codes and you can see here that this one matches a code used in our number 3 lock. All Python mechanism locks use our number 1 key and can be KA to existing keys as long as they don't have a number 7 depth in them.

The 379ATPY can be ordered KD or KA to the same codes that were available for the 377 coupler lock.



3489 LOCKING BALL MOUNT

This lock uses the standard Python™ plug for the key cylinder. It may be removed in the unlocked position with the Python™ removal tool and rekeying may be accomplished using the 8491 keying kit.

When servicing, if the lock operates roughly because of road dirt buildup or other contaminants, remove the Python™ cylinder and press inward on the locking bolts while impacting the rear of the mount on a hard surface. The entire lock will slide out of the mount to allow cleaning and lubrication.

Cylinders

Master Lock Company makes ten basic cylinder sizes/types for use in our padlocks;

1. A small diameter cylinder for some of our laminated locks.
2. A four pin cylinder for our laminated locks.
3. A five pin cylinder for our laminated rekeyable locks
4. A six pin cylinder for our ProSeries® locks.
5. A cylinder for our number 19 lock.
6. SFIC small format interchangeable core cylinders.
7. Cylinders compatible with various door hardware locks made by others.
8. Master Lock EDGE™ System
9. Python®
10. Universal Pin

1. The small diameter cylinder is generally referred to as the number W7 cylinder and is used in various products where the available space is limited. This cylinder is used in the number 7 laminated padlock, the gun lock, etc., and is generally not accessible for rekeying. In those cases where it can be rekeyed, it uses the same pins used in the first four classes above. Those pins are available in our #291 pinning kit found on page 28. See page 17 for service procedures.



2. The four pin cylinder is generally referred to as the number W1 cylinder and is used in the number 1, 3, 5 laminated padlocks, and many other products. In many cases it is not accessible for rekeying, but when it can be rekeyed you may use our #291 pinning kit. Servicing procedures may be found on page 17.



3. The five pin cylinder is generally known as our number W27 cylinder and is found in our laminated rekeyable locks such as the number 21, 24, 25, and 27. It may be rekeyed using our #291 pinning kit shown on page 28.



There are times when you may want to use a four pin cylinder in a lock designed for the five pin cylinder because of keyway compatibility. That can be accomplished by using the 27-0334 plug actuator which adapts the four pin cylinder to the five pin length.

4. The six pin cylinder is referred to by two different part numbers, depending on the number of pin chambers that are pinned. When pinned with only five pins, it is called the W6000 and if all six pins are used it is called the W7000. This cylinder is found in our ProSeries® products and may also be rekeyed using our #291 pinning kit.



Effective mid-2001, Master Lock Company implemented a new six pin cylinder and key. The cylinder changed from a crimp to an E-clip which reflects tighter tolerances between the plug and shell. The new key has a radiused blade bottom. This running change should have no effect on key operation from old to new cylinder types.



Cylinders *continued*

5. The W19 cylinder is only used in the number 19 lock and it is not really accessible for rekeying without drilling the rivets. This cylinder uses .125" diameter pins and a .025" increment. The shell is crimped on both sides and does not allow the service technique typical on the old style W1 cylinder. The only option available for rekeying would be to use the holes on the bottom of the shell to remove pins from the plug and replace them with new ones.



6. The Interchangeable Core cylinders are constructed to the SFIC standards that you encounter with many other brands. Keying uses the same techniques employed for those cylinders.

Master Lock offers IC cylinders keyed to existing key systems if you are able to supply the combinations for the operating key, the TMK (Top Master Key), and the Control key. Master Lock also has the ability to recreate your entire key system, including all potential expansion, if you can supply bitting combinations of all keys that have been used.



At present, Master Lock offers IC cylinders compatible with the A2 and A4 format from the factory. If you are equipped for pinning SFIC cylinders, you can key the cylinders into an existing A3 system without difficulty. The listing below allows construction of a correct SFIC cylinder part number when ordering from Master Lock.

CA604KD

Interchangeable Core

Keyway/Key Section

Manufacturer's Brand Name

- A – Best A Keyway
- B – Best B Keyway
- C – Best C Keyway
- D – Best D Keyway
- E – Best E Keyway
- F – Best F Keyway
- G – Best G Keyway
- H – Best H Keyway
- J – Best J Keyway
- K – Best K Keyway
- L – Best L Keyway
- M – Best M Keyway
- Q – Best Q Keyway
- W – Arrow 1C Keyway
- X – Arrow 1D Keyway
- Y – Master Lock Keyway

Keying Specification

- KD – Keyed Different
- KA – Keyed Alike
- UN – Uncombined
- KDMK – KD Master Keyed
- KAMK – KA Master keyed

Finish

- 04 – Satin Brass
- 26D – Satin Chrome

Number of pins

- 6 – six
- 7 – seven

Cylinders *continued*

7. The door hardware cylinders are rekeyable using standard .115" diameter pins. The plug is mounted to the shell with a ring retainer, and use of a follower is recommended for rekeying. In order to mount the cylinders in the lock, a cylinder retainer plug is placed over the bible of the cylinder. The retainer plug has a threaded hole used to mount it to the lock via the toe side shackle hole and the socket screw. This cylinder also requires a special driver to be placed between the cylinder tail and the lock actuator in order to function. The listing below allows construction of a correct cylinder part number when ordering from Master Lock.



D045KD

Door Hardware Cylinder

Keyway

Manufacturer's Brand Name	Keyway	Manufacturer's Brand Name	Keyway
Sargent LA-LC*	36	Sargent RA-RC*	70
Arrow 10		Sargent S*	02
Corbin 59A1-2 01		Sargent U*	02
Corbin 60 29		Schlage C	04
Corbin Russwin L4 07		Schlage E	34
Harloc SE-1* 02		Schlage P	28
Kwikset* 12		Segal 9.265	27
Lockwood 08		Weiser*/Falcon	13
Lori L200* 02		Weslock	33
Lori Locksmith 80 80		Yale 8	03
Loricentric 90 90		Yale GA	15
Master/Dexter 67* 32		Master Lock	200WP
Russwin 981/852 11		EDGE® System	
Russwin D1 30		(Available with 4 or 6 pins only)	

Keying Specification

KD	-	Keyed Different
KA	-	Keyed Alike
KZ	-	Zero Bitted
KDMK	-	KD Master Keyed
KAMK	-	KA Masker keyed
UN	-	Uncombined**

Number of pins

4	-	four**
5	-	five
6	-	six

* Indicates a composite keyway that accepts more than one key section. Example: Keyway 02 accepts the Sargent S, Sargent U, and Lori L200 keys.

** Exclusively available for the Master Lock EDGE™ Key Control System only.

8. The Master Lock EDGE™ System cylinders are available in both four and six pin versions. They are the subject of utility patent 7,040,126. A secondary independent locking mechanism utilizing ball bearings on each side of the keyway offers creation of virtual keyways for a key control system along with the special actual keyway for the keys.

This cylinder has two 3/32" diameter ball bearings on each side of the keyway. The ball bearings are not spring loaded and are not staked into place in the plug. Care should be observed when removing the plug from the shell.

Plugs are normally drilled with only one hole for ball bearings on each side of the keyway and therefore dedicated to the virtual keyway associated with those positions. Distribution of virtual keyways is controlled geographically and the product and key blanks are only sold via locksmith distribution

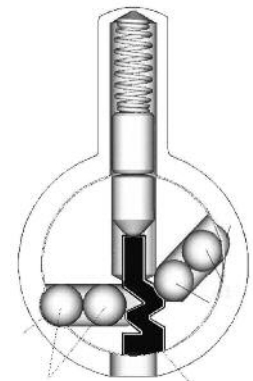

Cylinders *continued*



NOTE: The Master Lock EDGE™ key control is compatible with the American Lock® EDGE™ Padlock and Door Key Control System. Cylinders for Door Hardware locks are only available as an American Lock® EDGE™ product and have a standard size shell for a mortise, rim and KIK application. The plugs for those cylinders have a head that has a diameter typical of that found in door hardware cylinders but the plug itself has the same .397" diameter found in the padlock cylinders.

That means the same 291 keying kit can be used for keying and all bittings and virtual keyways will be the same as found in the padlock cylinder versions. All sizes and types of door hardware compatible cylinders in the EDGE™ system will have 6 pin chambers, even the 1" mortise cylinders. The Nickel-Silver keys introduced with this product are the standard for the American Lock® EDGE™ System cylinders to offer the added strength needed for this type of cylinder.

9. The Python cylinder has a removable plug that uses a disc tumbler mechanism and two inwardly sprung sidebars for pick resistance. Supplied with the number 1 keyway, it is a rekeyable plug that can be used in an increasing range of our automotive related products.



10. The Universal Pin cylinder. This cylinder is unique in its design and use. When assembled at the factory it uses a pin tumbler that is both a bottom pin and a top pin without the division between the two. This serrated pin is placed in the first four of five pin chambers and a standard driver pin is placed in the last chamber. The serrations on the pin are made at .015" increments and designed to be located where a shear line might be created.

The UP product is a patented design that allows 'setting' a lock to a customer key without disassembly. There are some simple steps to follow that ensure the customers key will operate.

- a. Check the key for excessive wear. If worn, use a code cut key to set locks.
- b. Insert and withdraw the key a few times to ensure that the pins are moving freely and seating on the key.
- c. Place the 376 keying tool over the head of the key and in firm contact with the plug face.
- d. Strike the keying tool once firmly with a hammer to shear all four pins at the shear line.
- e. Strike the keying tool once more to ensure that the plug is fully seated and the newly created top pin in the first chamber can extend into the groove around the plug and act as a plug retainer.

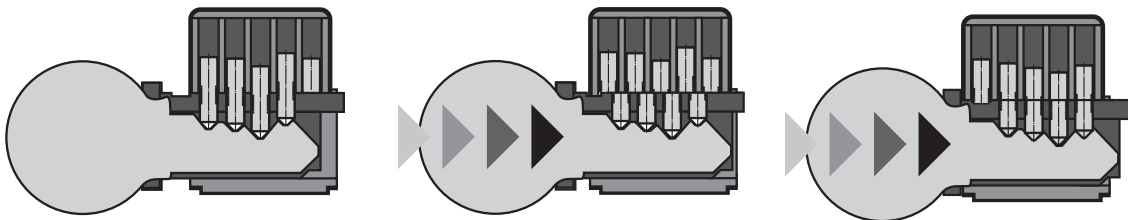
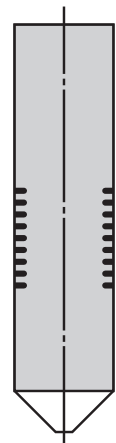

Cylinders *continued*

To assure that the plug is properly seated you can pinch the key to remove the first time. If it removes easily the plug is properly seated. If it won't withdraw, use the keying tool to seat the plug again.

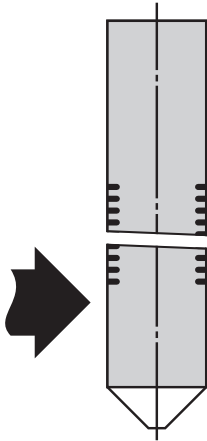

The basic rules to follow with this product are to use a key with as little wear as possible to set the lock, and to never set more than six locks with the same sample key.

When the pins are sheared they are not sheared exactly in a straight line. Because the diameter of the pin chamber must allow free travel of the pin, it is larger than the pin. When the breaking force is applied to the pin it tilts a little inside the pin chamber before it shears. That means that one side of the pin is generally higher than the other.

As that higher edge passes under the pin chamber wall the pin is pushed into the bottom of the key cut. Each time the key is used to set a lock this happens and makes a dent .0005" deeper than the cut you started with. That is why the same sample key shouldn't be used to set more than six locks.

The 376 keying tool is designed to assist in setting a lock to a key and other devices not specifically designed for the UP series products should not be used.



Cylinder Service Procedure

Older style ProSeries® cylinders and most other Master Lock cylinders may be serviced with the metal follower in the 291 pinning kit or via the service holes in the bottom of the shell. Some very specific steps must be followed when rekeying via the service holes but after the first time the rekeying can be accomplished more quickly than using a follower.

This procedure will work on cylinders that have a crimp retainer as well as cylinders that use a clip retainer, but will not work on EDGE™ cylinders.

1. Hold the cylinder with the service holes up.
2. Insert a working key and rotate 180°.
3. Remove existing bottom pins via service holes.
4. Rotate plug 90° Clockwise.
5. Remove old key and insert new one.
6. Rotate plug Counter-Clockwise 90°.
7. Insert new bottom pins to match new key combination.
8. Rotate plug 180° and remove key.

If you are rekeying and Master Keying the cylinder, complete disassembly with a follower is recommended as that will allow the removal of extraneous master pins from the bible as well as the plug.

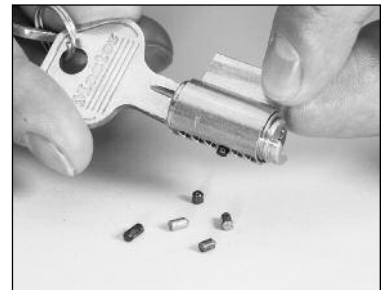

Cylinder Service Procedure *continued*

All ProSeries® locks are supplied with a six pin length cylinder for uniform keying capability. The ProSeries® cylinder may be combined with 4, 5, or 6 pins to accommodate existing key codes.

Pin chambers in this cylinder are drilled from the shell into the bible. Care should be exercised to avoid turning the plug 180° because, at that point, the bottom pins will align with the service holes on the bottom of the shell and could be lost.

1. The plug is held in the shell via a crimp in the end of the shell.
This crimp prevents removal of the plug from the shell unless you have a Master Lock plug follower with a flat on it.
2. The bottom of the plug is undercut at the keyway to allow it to bypass the crimp. The Master Lock plug follower is designed to fit the end of the plug and automatically align with the crimp in the shell.
3. To remove the plug, turn it 90° counterclockwise and, with the special plug follower, push the plug from the shell.

Once you have changed the pinning combination, insert the plug into the shell.

Effective mid-2001, the crimp retainer was replaced with a new design E-clip. To service the current cylinder, remove the E-clip and then follow step 3 above. This running change replacement eliminated the crimped retainer for the plug in all ProSeries® 6000 and 7000 keyway cylinders. This new design cylinder was also supplied with a new key design. The new keys have radiused blade bottoms and the section stamping includes a suffix “B” for ease of identification (see 23).



Rekeyable Cylinders					
No. of Pins	Keyway	Part Number by Cylinder Length			Keying
		4 Pin	5 Pin	6 Pin	
4	K1	294W1*	294W1*	296W1	KD
4	KWP4	294WP4*	294WP4*	296WP4	KD
5	K15	N/A	295W15	296W15	KD
5	K17	N/A	295W17	296W17	KD
5	K27	N/A	295W27	296W27	KD
5	K81	N/A	295W81	296W81	KD
5	K600A	N/A	295W600	296W600A	KD
6	K700A	N/A	N/A	296W700A	KD
5	K6000	N/A	N/A	296W6000	KD
6	K7000	N/A	N/A	296W7000	KD
6	KWP6	N/A	N/A	296WP6	KD

* Includes extension for a 4 pin cylinder in a 5 pin lock

NOTE: For KA or MK, insert that specification in front of the 'W' in the above part number.

For Zero Bitted, use suffix 'KZ' with above part number

Servicing the BumpStop® Mechanism



Cylinders containing the BumpStop® mechanism pin have one different component than standard cylinders and may be rekeyed when required. That one different component is the BumpStop® top pin. It is longer than a typical top pin and will only let the cylinder operate correctly when it is placed in a correct pin chamber.

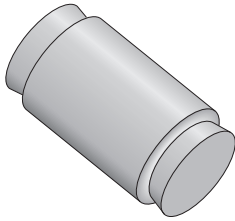

The table below indicates where the BumpStop® pin may be used in the different types of locks. The letter X in the table indicates a cut depth that isn't available in the product or a cut depth that isn't compatible with the BumpStop® pin.

When rekeying you need to figure out which pin chamber has the BumpStop® pin in it and be sure to change where it is for the new combination of the new key.

For example, if you have a cylinder that was keyed to the combination 42645, the BumpStop® pin would be in the second pin chamber. If your new key has a combination of 54624, you would need to move the BumpStop® pin in the cylinder from the second to the fourth pin chamber.

Cut #	Master Doorlock	Master Padlock	Padlock KIK	American Padlock
0	X			X
1				
2				
3		X	X	

Failure to move the pin will certainly make the cylinder vulnerable to a Bump Key attack and may make it impossible to even insert some cut keys because of the extra length of the BumpStop® driver pin.

DUMP THE BUMP PIN

A good practice when keying a cylinder with BumpStop® technology is to always dump the Bump Pin. That way when you rekey it you can always put it into a valid location.

Keying

Master Lock keys are coded from bow to tip and with a few exceptions, the increment used is .0155". Master Lock keys will be encountered with two types of stamping on them. Both direct and blind codes are stamped on the keys for different products. In the 291 pin kit you will find the 290-0371 key gauge for decoding keys. The "B" series of keys, 6000B and 7000B, use gauge 290-0373. For ProSeries® products, use the top slot in the gauge. Insert the key in the slot at the large end perpendicular to the gauge. Once inserted, pull the key toward the smaller end of the slot until it stops. The number stamped on the gauge directly below where the key stops is the cut depth for that cut position on the key. Repeat the process for each cut position on the key to determine the actual combination of the key.

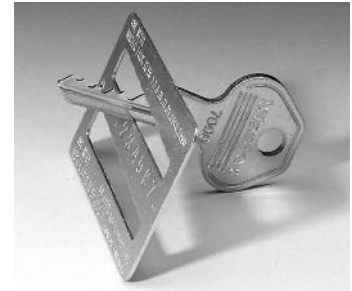

The cylinder being rekeyed may be set to an existing key combination or it may be zero-bitted. In either case, follow the plug out of the shell and discard the existing pins from the plug. If the cylinder was Master Keyed, also remove any master pins that may have been retained in the shell. For the combination decoded, select the appropriate length pin from the 291 pinning kit, and install in the appropriate pin chamber of the plug. Once all pins have been installed, insert the plug into the shell and check for smoothness of operation. If you note roughness in the operation, check the key to be sure it has been produced to the bitting specifications on page 25.

MASTER KEYING

Most keying system software offers the option of providing a pinning chart. It is advisable to use that option. If the option is not available, the following example illustrates the procedure required to determine the pinning of a master keyed cylinder.

With the example master key combination of 047345 at right, and the change key combination of 405253, the first step is to figure out the bottom pins that you must install in the cylinder, then the required master pins must be determined.

Bottom pins must be selected to allow operation of the shallowest cut per position in the cylinder for either key. By comparing the two combinations, select the shallowest cut for each cut position from either key. In our example we have highlighted the shallowest cut depth, and you can see that our bottom pins for the cylinder will be 005243. The master pin sizes are determined by subtracting the shallowest cut depth from the deepest cut depth for each pin position in the lock. As noted in the example, the difference is 442112.

From this process, we know that in the first pin chamber we must have a number zero bottom pin and a number 4 master pin for both keys to operate. The illustration at the right shows the pinning for the master keyed cylinder example. Depending upon the size of your key system, you may or may not require master pinning in all of the pin chambers.

If you find that some cylinders require master pins in different pin chambers or if different cylinders require different quantities of pin chambers to have master pins, question the design of the system before proceeding. Having master pins in different pin chambers may indicate that the system utilizes a Rotating Constant Method of progression, which should be verified. Having different quantities of master pins in different cylinders usually indicates faulty key system design, and you should recommend that the system be replaced.

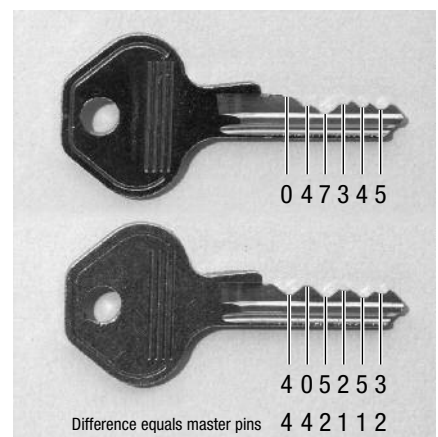
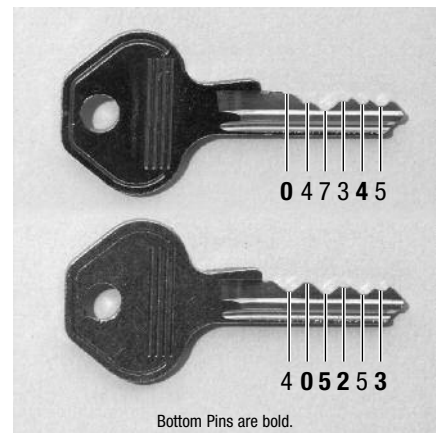

Use of the service holes is another optional method for rekeying if the cylinder hasn't been, or doesn't need to be master keyed. While the steps are more numerous it often proves to be a quicker method than using a follower. The procedure is;

- Insert key and rotate 180° to remove existing bottom pins via the service holes
- Without removing the key, rotate the plug another 90°
- Remove the old key and insert the new one
- Rotate the plug back to the 180° position and install new bottom pins via the service holes
- Rotate the plug to the key pull position and remove key

Keying *continued*

EDGE™ KEY CONTROL SYSTEM

The new EDGE™ System has a secondary locking mechanism in the form of two ball bearings on each side of the keyway. The nickel-silver keys have a dimple cut on each side of the new actual key section.

The ball bearings are required to align with a slot in the shell before the key can be removed and that means that the service holes on the bottom of the shell cannot be used for rekeying as with other ProSeries® cylinders. When using a follower during rekeying care should be taken to retain the ball bearings in the plug because they are not staked in place and can be lost.

The technique of rolling your fingers along the plug as it is removed has proven effective. If ball bearings are lost, they can be replaced with any standard 3/32" ball bearing and Master Lock sells a package of 200 via part number 296-0200, they are also included in the regular #291 keying kit.

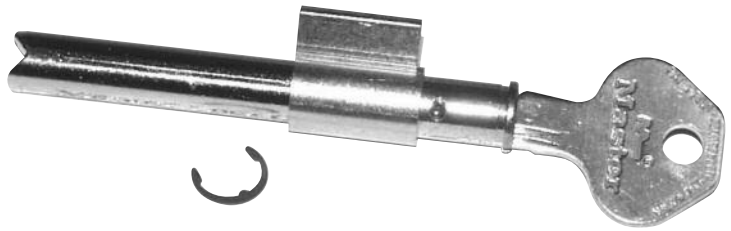

These cylinders and keys are 100% compatible with the American Lock EDGE™ mortise, rim and knob style cylinders. The American Lock EDGE™ products use a nickel silver key for the added strength needed in door lock applications.

NOTE: If one or more of the ball bearings is left out of the cylinder during reassembly there is a danger of one of the top pins entering the ball bearing hole and rendering the cylinder useless. Missing ball bearings also eliminate the key control potential in the particular cylinder.

EDGE™ KEY CONTROL SYSTEM MASTER KEYING

The EDGE™ System products require application of one important rule regarding key system development. Number one master pins cannot be used in any EDGE™ cylinder. Those cylinders each have two slots in the shell for the ball bearings and if a number one master pin in the plug falls into one of those slots it will jam the cylinder preventing further rotation of the plug or withdrawal of the key.

If you do not have the capability to produce keying systems that have eliminated the need for number one master pins, Master Lock will generate a system for you with up to four levels of keying and a total of 20,000 CK's in the system for a six pin cylinder. Master Lock has a flat fee for this service but you must realize that a copy of the key system will not be retained by Master Lock Co. A pinning matrix is also supplied with the keying system on a CD_ROM.

PYTHON™ PLUG

The Python plug may be removed from the lock housing with a service key if the plug is in the unlocked position. If the plug isn't in the unlocked position the differently sized tenons on the back of the plug won't let it be removed.

The Python plug also interacts with a circular actuator inside the lock body and that actuator is located only by the plug. Before using the service key to remove the plug the cable should be removed from the lock body and the body should be stored carefully when the plug has been pulled for rekeying to avoid displacing the actuator. Displacement of the actuator effectively destroys the lock.



Keying *continued*



The disc tumblers are the snap in style and a special keying tool is available for rekeying. This tool is also supplied in the keying kit for the Python. One major difference in the Python versus a standard laminated padlock is the number of depths available. Normally Master's number 1 key has the potential for 8 depths, (0 through 7), but the Python only has 7, (0 through 6). The majority of locks using the number 1 key don't use a number 7 depth, but if you encounter one that does, it cannot be keyed into the Python plug.



The keying kit also includes a key gauge, four different spare plugs and two service keys.



The keying tool has a tooth on it that can be positioned on a disc tumbler to remove it from the plug. The inner portion of the jaws on the tool is ideal for pressing the tumblers into the plug.

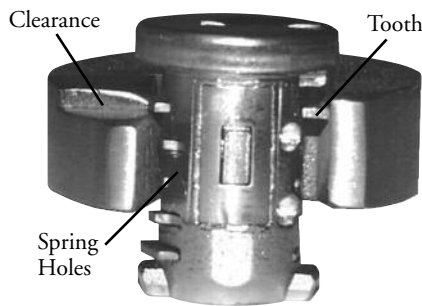

Removal of a tumbler is best accomplished as shown in the illustration at left. The tumbler will be ejected into the clearance area of the tool and then may be exchanged for the desired tumbler.

The fifth tumbler is a steel retainer tumbler. This tumbler has a long side and a short side and the longer side is the side that should be placed over the spring.

Once rekeying has been accomplished the service key can be used to replace the plug in the lock body and the key should be pinched to allow removal without pulling the plug.

Product Category	Model Numbers	Plug Assembly
Python™ Adjustable Locking Cables	8401D, 8402D, 8413	8401-0337
Key Cabinets	7122D – 7128D	8401-0338
Automotive Security	1470DAT, 2847DAT, 2854DAT, 2878DAT	8401-0339
Automotive Security	739DAT, 2989AT, 8287DAT, 8289AT	8401-0340

Improved Pro Series® Cylinders

CYLINDER AND KEY ENHANCEMENTS

In August 2001, Master Lock made enhancements to our W6000 and W7000 cylinders used in the Pro Series™ padlocks. The tighter manufacturing tolerances expand the number of key codes available while at the same time reducing the risk of inadvertent key interchange.

The keys affected are the 6000 and 7000. Rounded bottom keys stamped 6000B and 7000B have replaced them.

New “B” keys and old keys can be used in the exact same padlock. Just be sure to use care when duplicating the key. If you do not have the exact same blank as the key you are duplicating, you must cut by code to avoid the new cut key from being off by .0125" and unusable.

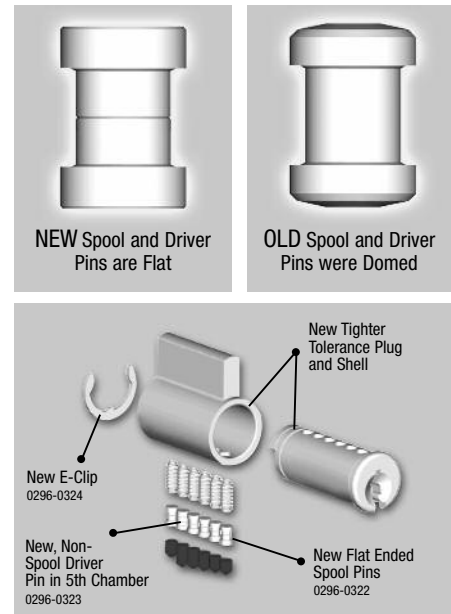

NEW KEYS ROUND ON THE BOTTOM

Avoid duplicating an old style key onto a new “B” style round-back blank. Cuts will be .0125" too deep. Use codes below to cut.

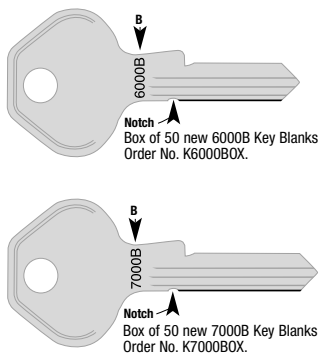

Cut	Root Depth
0	.2845"
1	.2690"
2	.2535"
3	.2380"
4	.2225"
5	.2070"
6	.1915"
7	.1760"



OLD KEYS FLAT ON THE BOTTOM

Avoid duplicating a “B” round-back key onto an old style blank. Cuts will be .0125" too shallow. Use codes below to cut.

Original blanks no longer available.

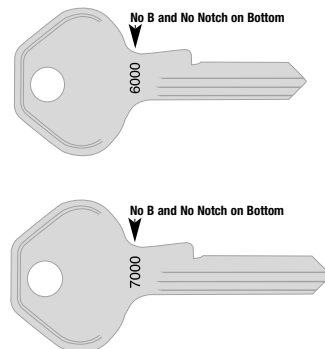

Cut	Root Depth
0	.271"
1	.256"
2	.240"
3	.225"
4	.209"
5	.194"
6	.178"
7	.163"



Keys and Keyways

Master Lock uses a wide range of keys and keyways. Below illustrates the relationship of keys to keyways and the corresponding part numbers.

Four Pin

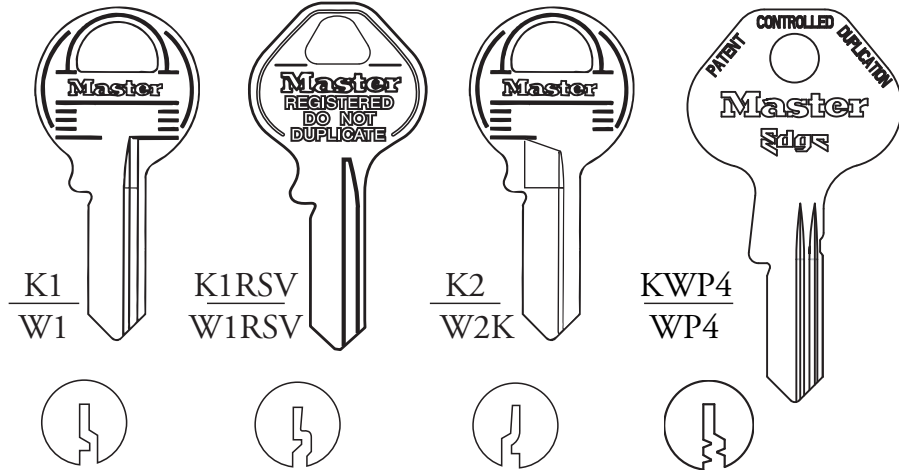

Five Pin

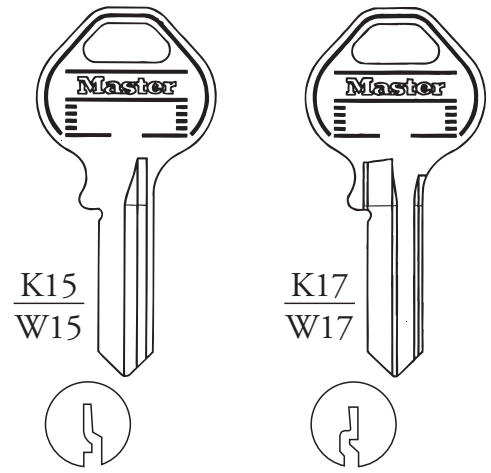

Five Pin

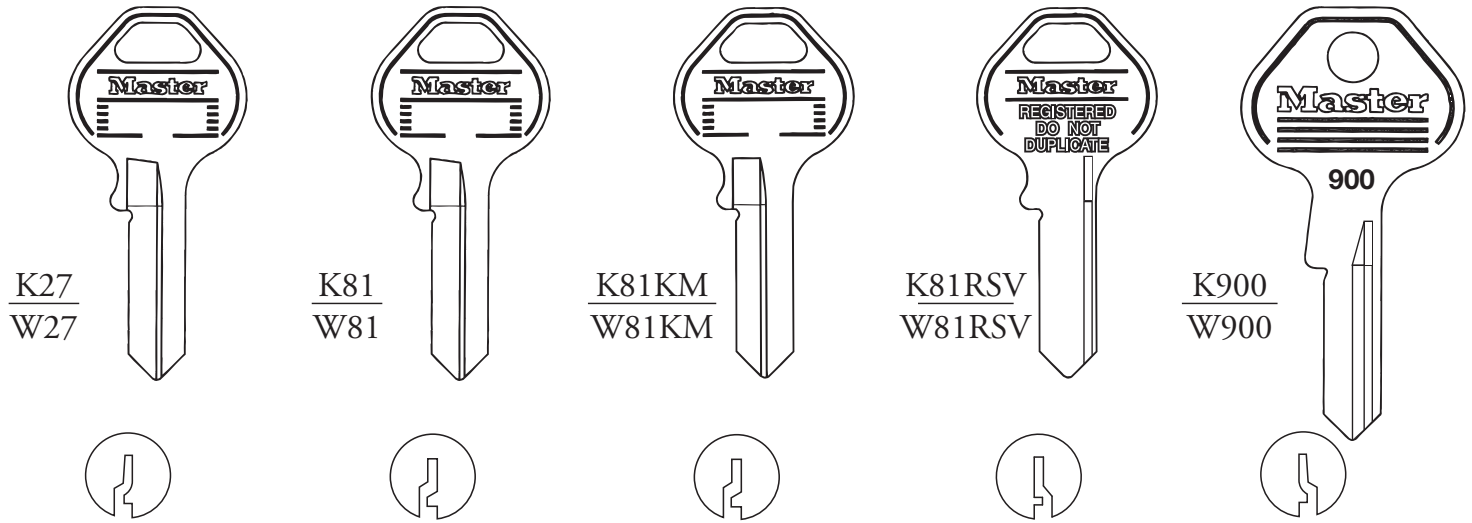

Five Pin

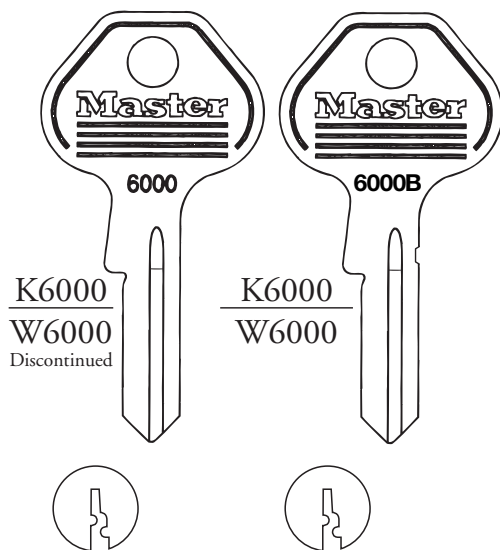

Six Pin

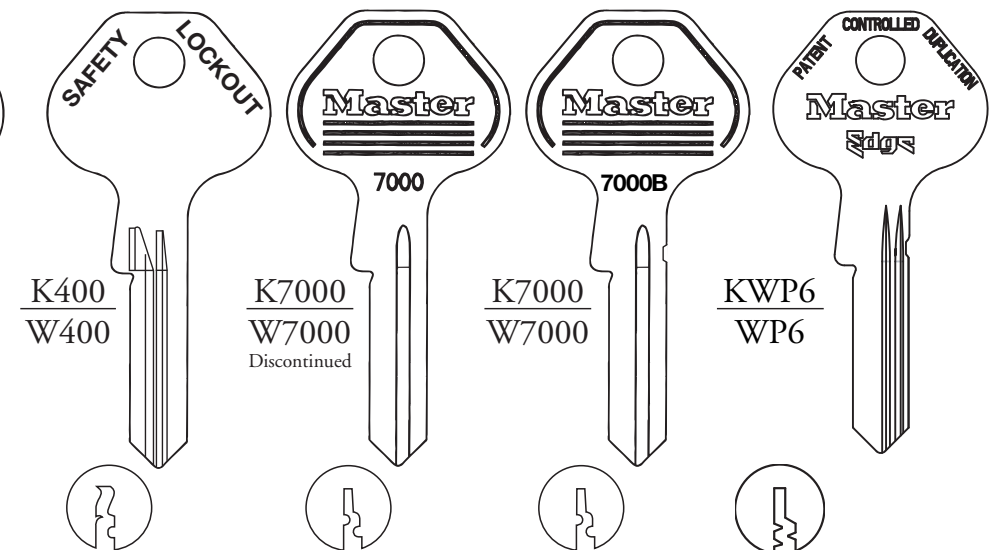

Bitting Specifications

Key Blank Part Number	Key Blank Width	Root Depth										Spacing Stop To First Cut	Spacing Cut To Cut	Used in Master Lock	
		0	1	2	3	4	5	6	7						
1K	0.281	0.2720	0.2565	0.2410	0.2255	0.2100	0.1945	0.1790	0.1635	0.187	0.125	1,2,3,4,5,6,11,77,33,34,35,36,37,39,425,475			
2K	0.281	0.2720	0.2565	0.2410	0.2255	0.2100	0.1945	0.1790	0.1635	0.187	0.125	1MK,2MK,3MK,4MK,5MK,6MK,11MK			
1RES	0.277	0.2770	0.2615	0.2460	0.2305	0.2150	0.1995	0.1840	0.1680	0.187	0.125				
7K	0.212	0.2120	0.1965	0.1810	0.1655	0.1500	0.1345	0.1190	NA	0.132	0.125	7,8,90,716,719			
7RES	0.208	0.2080	0.1925	0.1770	0.1645	0.1460	0.1305	0.1150	NA	0.132	0.125	7,8,90			
15K	0.272	0.2720	0.2565	0.2410	0.2255	0.2100	0.1945	0.1790	0.1635	0.187	0.125	15			
17K	0.272	0.2720	0.2565	0.2410	0.2255	0.2100	0.1945	0.1790	0.1635	0.187	0.125	17			
19K	0.374	0.3720	0.3470	0.3220	0.2970	0.2720	0.2470	0.2220	0.1970	0.218	0.156	19			
27K	0.283	0.2720	0.2565	0.2410	0.2255	0.2100	0.1945	0.1790	0.1635	0.187	0.125	21,24,25,27,31,101,220,230			
52K	0.277	0.2720	0.2565	0.2410	0.2255	0.2100	0.1945	0.1790	0.1635	0.187	0.125	8179			
81KR	0.283	0.2820	0.2665	0.2510	0.2355	0.2200	0.2045	0.1890	NA	0.187	0.125	50,81,82,1710,1714			
81KM	0.283	0.2820	0.2665	0.2510	0.2355	0.2200	0.2045	0.1890	0.1735	0.187	0.125	81MK,82MK,1710MK,1714MK			
81RES	0.283	0.2740	0.2585	0.2430	0.2275	0.2120	0.1965	0.1810	0.1655	0.187	0.125				
120K	0.200	NA	0.1950	0.1750	0.1550	0.1350	NA	NA	NA	0.132	0.12	120			
130K	0.270	0.2700	0.2400	0.2100	0.1800	0.1500	0.1200	NA	NA	0.132	0.12	130,140			
150K	0.270	0.2700	0.2400	0.2100	0.1800	0.1500	0.1200	NA	NA	0.150	0.129	150,160			
600K	0.308	0.2840	0.2684	0.2528	0.2372	0.2215	0.2059	0.1903	0.1747	0.159	0.125	220,230 w/American cylinder			
700K	0.308	0.2840	0.2684	0.2528	0.2372	0.2215	0.2059	0.1903	0.1747	0.159	0.125	All Pro Series® w/American cylinder			
900K	0.272	0.2720	0.2565	0.2410	0.2255	0.2100	0.1945	0.1790	0.1635	0.187	0.125	Retail Contractor Grade			
K2650	0.283	N/A	0.2637	0.2440	0.2240	0.2045	0.1850	N/A	N/A	0.2830	0.125	2650 ADA Lock			
6000K	0.283	0.2710	0.2555	0.2400	0.2245	0.2090	0.1935	0.1780	0.1625	0.187	0.125	All Pro Series® 5 Pin cylinders			
7000K	0.283	0.2710	0.2555	0.2400	0.2245	0.2090	0.1935	0.1780	0.1625	0.187	0.125	All Pro Series® 6 Pin cylinders			
Keys with Radiused Blade Bottom (stamped 6000B and 7000B) Effective August, 2001															
6000K	0.290	0.2845	0.2690	0.2535	0.2380	0.2225	0.2070	0.1915	0.1760	0.187	0.125	All Pro Series® 5 Pin cylinders			
7000K	0.290	0.2845	0.2690	0.2535	0.2380	0.2225	0.2070	0.1915	0.1760	0.187	0.125	All Pro Series® 6 Pin cylinders			
WP4&6	0.290	0.2845	0.2690	0.2535	0.2380	0.2225	0.2070	0.1915	0.1760	0.187	0.125	All ML® System cylinders			

ProSeries® Actuators and Drivers

ACTUATORS

As noted in the exploded views, all ProSeries® locks use an actuator mechanism that causes the ball bearings to lock or unlock the shackle. Typically ProSeries® locks are supplied with a NKR, Non Key Retaining, function actuator. There are five different variations of an NKR actuator you may encounter as shown here.

The two actuators on the right are the original 8 o'clock position type used in the Weather Tough®, Shrouded, Solid Body Brass and Solid Body Aluminum locks and also the Door Hardware compatible Solid Steel Body locks.

The two actuators on the left are the newer 12 o'clock versions used in all current Solid Body locks except the Door Hardware compatible Solid Steel locks. The middle actuator is used only in the 6230 lock.

The differences are in the size of the actuator and the location of the projection on the spring washer. The position of that projection inside the lock is critical to lock operation. Care should be taken to note the position when disassembling a lock so that it may be reassembled correctly. In the picture, the actuator on the left is called a 12 o'clock style and the one on the right is called the 8 o'clock style.

In 2010 the shape of the actuators was changed for the Pro-Series® locks to a die-cast version. This die cast version spreads force from the ball bearings over a wider surface to inhibit shackles from pulling out in the unlocked position.

There are three different actuators to provide the NRK, Non Removable Key, function and they are show here. Special care should be taken to position them correctly within the lock during assembly.

The two actuators pictured on the right are used in the revised 6835 padlock manufactured after September 2013. The revised 6835 padlock can be identified by its rectangular body style. The APKG0001669 (with spring) is for the Non Key Retaining (NKR) function. The APKG0001670 (without spring) is for the Non Removable Key (NRK) function.

DRIVERS

The door hardware locks require a driver to allow the door hardware cylinder to drive the actuator. There are four driver types available and they are shown on the right. Shown is the distinctive feature of the driver that engages the cylinder.

Positioning the driver on the cylinder should always be done to ensure that the orientation of the driver forms the assembly profile at the right.

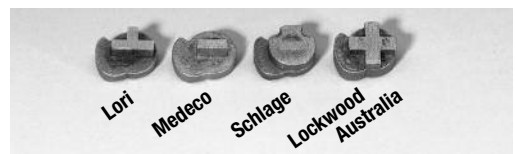
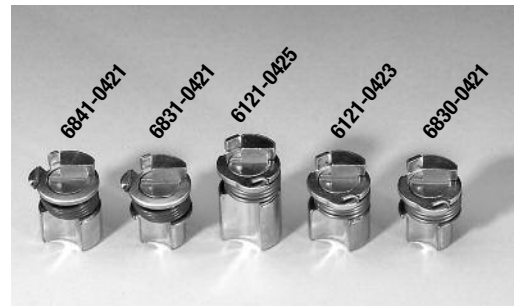

ProSeries® Actuators and Drivers *continued*

The Lori cylinders are available from Master Lock as part of the lock assembly and will be supplied with the 298-0626 driver. If you are using a Medeco 20-20000 or 20W20000 cylinder you should use a number 298-0627 driver. For all Schlage cylinders and the ASSA 65611 cylinder for the padlock you can use a 298-0628 driver. The number 298-0625 driver is used to adapt an Australian Lockwood cylinder.

Medeco also offers a cylinder for the padlock that can be used without a driver. Use a 51-0600 or a 51W0600 cylinder for that option, but realize that the same cylinder will not be adaptable to a door hardware lockset.

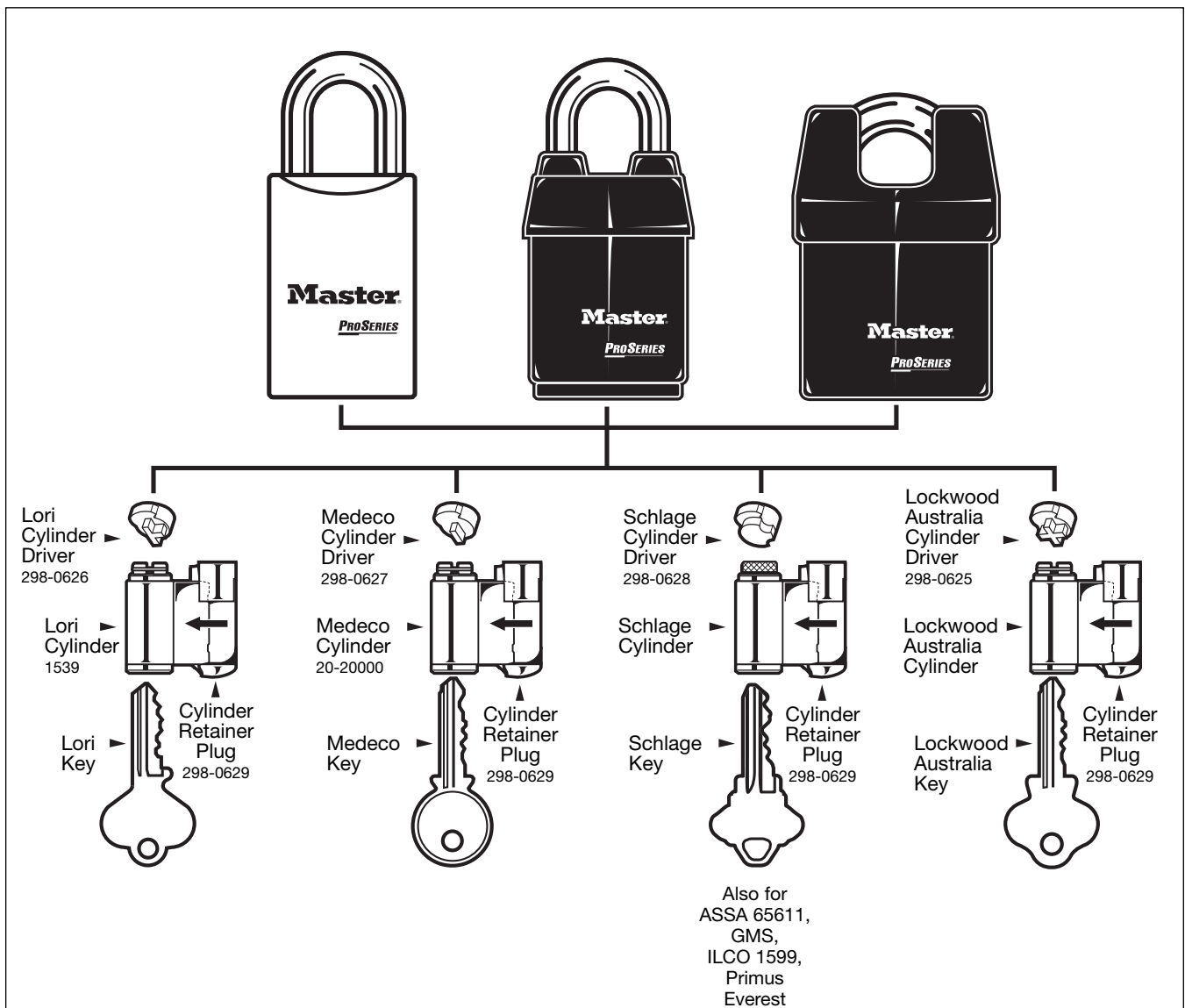

Tools

The 291 Pin Kit includes all tumbler and driver pins needed to repin Master Lock rekeyable padlocks (not IC or Door Hardware pins though). It also includes several tools to assist in rekeying the cylinder. The 8491 keying kit includes all tumblers needed to rekey the Python cylinder plug. It also includes a special keying tool, service keys and a key gauge.

Parts included in 291 Rekeying Kit

Plug Extender

27-0334

Key Cut Gauges

290-0371 for all keys but 6000B and 7000B

290-0373 for 6000B and 7000B keys

Cylinder Assembly Tool

290-0372 Follower

APKG0060612 EDGE™ Follower

Hex Wrenches

1/16" American Lock® EDGE™ Wrench

3/32" – For Rekeyables

7/64" – For Rekeyables

1.5mm for 6270 & 6271 not included (purchase locally if needed)

Trap Doors

21-0372 for 21, 24, 101 padlocks

27-0371 for 27 padlock

6121-0420 for many Pro Series

6830-0023 for many Pro Series

Also includes a wide assortment of retaining nuts, springs and pins for rekeyable padlocks and ball bearings for EDGE™ Key Control products.

291 Rekeying Kit



Parts included in 8491 Rekeying Kit

Key Cut Gauge

290-0371 for all keys but 6000B and 7000B

Rekeying Tool

8401-0371

Plug Assemblies

8401-0337, 8401-0338, 8401-0339, 8401-0340

Driver Springs

8401-0369

Service Keys

8401-0370

Disc Tumblers

No. 0 – 8401-0360 No. 3 – 8401-0363 No. 6 – 8401-0366

No. 1 – 8401-0361 No. 4 – 8401-0364

No. 2 – 8401-0362 No. 5 – 8401-0365

Cylinder Retaining Disc

8401-0368

8491 Python Rekeying Kit





Lock Lubricants

**Available Late
Fall 2010**

Master Lock Lock Lubricant can be used for lubricating the various lock components. The lubricants contain PTFE formulations that can be used for padlocks, door locks, automotive, marine, and multipurpose applications. The effective operating temperature range is -40°F to 500°F and helps de-ice pre-lubricated locks.

Two aerosol sizes are available that contain a “dry” lubricant formula that lubricates without collecting dirt or dust. The 2305 aerosol is a 5.25 oz. size convenient for carrying to jobs and the 2311 aerosol is an 11 oz. size ideal for keeping in the shop.



Recommended Padlock Cleaning & Lubrication

Over time, dust particles and chemicals in the air settle on and in the padlock. They can then create friction inside the precision locking and keying components and impede the opening and closing of the padlock. Annual cleaning is recommended. In particularly dusty or corrosive environments, clean every three months.

Recommended Directions:

- Flush grease and dirt from the padlock as needed.
- Apply Master Lock® Lock Lubricant to the keyway and shackle holes, using a very light spray. “Psst”, not “Psssssssssssssst”!
- Insert key, open and close padlock several times to distribute lubricant.

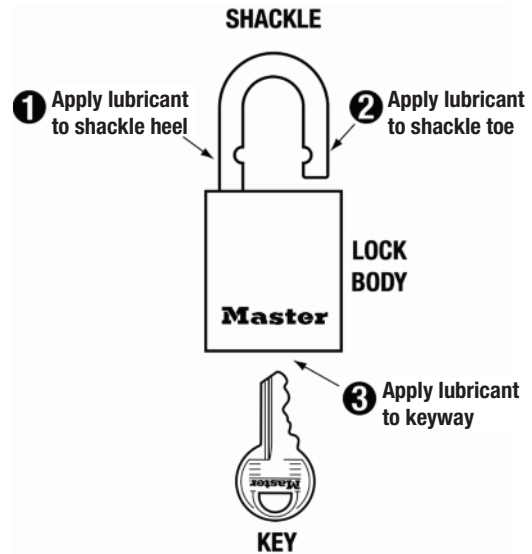

Average number of times opened per day	Dry Lubricant Application Schedule (Normal Environment)
1 to 50	Once per year
51 to 100	Twice per year

Terminology

When making a definition of a term, the following rules were applied to the term:

1. Is the term listed in a standard dictionary?
2. Is the definition there the same meaning used in our industry?

A standard pocket dictionary can be obtained easily and on short notice from a variety of stores that have a pocket book display. If the answer to either of the questions above is no, then the definition of the term may be found here.

A definition must meet the following rules:

1. It must describe the subject of the term without graphics.
2. It must describe ONLY the subject of the term.
3. The term should not be used in the definition.

If you have a technical objection to any definition, please bring it to the attention of a member of the LIST Council for review.

Used by permission. Copyright © 1989, 1990, 1995, 1996, 1997 LIST Council

-A-

actual key section n. the exact cross sectional configuration of a key blade as viewed from the bow toward the tip

actuator n. a device, usually connected to a cylinder, which, when activated, may cause a lock mechanism to operate

ADA abb. Americans with Disabilities Act

adjustable mortise cylinder n. any mortise cylinder whose length can be adjusted for a better fit in doors of varying thickness

all-section key blank n. the key section which enters all keyways of a multiplex key system

ALOA abb. Associated Locksmiths of America, Inc.

associated change key n. a change key which is related directly to particular master key(s) through the use of constant cuts

associated master key n. a master key which has particular change keys related directly to its combination through the use of constant cuts

ASTM abb. American Society for Testing and Materials

auxiliary lock n. any lock installed in addition to the primary lockset

-B-

ball locking adj. a method of locking a padlock shackle into its case using ball bearing(s) as the bolt(s)

battery eliminator n. an electric device designed to provide energy to equipment normally requiring batteries for operation

bible n. that portion of the cylinder shell which normally houses the pin chambers, especially those of a key-in-knob cylinder or certain rim cylinders

bicycle padlock n. a padlock with sufficient shackle clearance to secure a bicycle

bi-directional cylinder n. a cylinder which may be operated in a clockwise and counterclockwise direction by a single key

binary cut key n. a key whose combination only allows for two possibilities in each biting position: cut/no cut

binary type cylinder or lock n. a cylinder or lock whose combination only allows for two biting possibilities in each biting position

bit n. the part of the key which serves as the blade, usually for use in a warded or lever tumbler lock v. to cut a key

bit key n. a key with one or more projecting bits

bitting n. 1. the number(s) which represent(s) the dimensions of the key 2. the actual cut(s) or combination of a key

bitting depth n. the depth of a cut which is made into the blade of a key

bitting list n. a listing of all the key combinations used within a system. The combinations are usually arranged in order of the blind code, direct code, and/or key symbol.

bitting position n. the location of a key cut

blade n. the portion of a key which may contain the cuts and/or millings

blank adj. uncut, see also "key blank"

blind code n. a designation, unrelated to the bitting, assigned to a particular key combination for future reference when additional keys or cylinders may be needed

block master key n. the one pin master key for all combinations listed as a block in the standard progression format

BMK abb. block master key

bolt n. any movable projection which blocks the movement of one object relative to another

bottom of blade n. the portion of the blade opposite the cut edge of a single bitted key

bottom pin n. usually a cylindrical shaped tumbler which may be conical, ball shaped or chisel pointed on the end which makes contact with the key

bow n. the portion of the key which serves as a grip or handle

bow stop n. a type of stop located near the key bow

box of wards n. a complete unit of intricate wards installed in or on a lock case

bridge ward n. a center ward attached to the interior of a lock by means of a bracket

broach n. a tool used to cut the keyway into the cylinder plug v. to cut the keyway into a cylinder plug with a broach

build-up dimension n. 1. the distance between two different shear lines, as expressed in units of the manufacturer's increment or as an actual measurement 2. the dimension of the build-up pin required in a particular chamber, which will allow one key to operate at the plug shear line and a different key to operate at a different shear line

build-up pin n. the additional element of a pin stack required to allow operation at different shear lines in a cylinder

bump key n. a lock picking key with uniform steeples between cuts that is forced further into the lock via impact

by-pass tool n. a device that neutralizes the security of a locking device, or its application hardware, often taking advantage of a design weakness

-C-

cam n. 1. a lock or cylinder component which transfers the rotational motion of a key or cylinder plug to the bolt works of a lock 2. the bolt of a cam lock

cam lock n. a complete locking assembly in the form of a cylinder whose cam is the actual locking bolt

cap n. 1. a spring cover for a single pin chamber 2. a part which may serve as a plug retainer and/or a holder for the tailpiece v. to install a cap

Terminology

capping block n. a holding fixture for certain interchangeable cores which aids in the installation of the caps

case n. the housing or body of a lock

case ward n. any ward directly attached to or projecting from a lock case

chamber n. any cavity in a cylinder plug and/or shell which houses the tumblers

change key n. a key which operates only one cylinder or one group of keyed alike cylinders in a keying system, see also "reset key" definition 1

changeable bit key n. a key which can be recombined by exchanging and/or rearranging portions of its bit or blade

Chubb shackle n. a hinged shackle with a pierced hole for the bolt in its movable end

CK abb. 1. change key 2. control key

devis n. a device to permanently attach a chain to a padlock

clipper n. a hand held key biting punch, often incorporating a triggerlike handle

closed gated adj. pertaining to a lever tumbler whose gate is pierced into the body of the tumbler. The lever(s) surround the fence in both the locked and unlocked positions.

clutch n. that part of a profile cylinder which transfers rotational motion from the inside or outside element to a common cam or actuator

CML abb. the title "Certified Master Locksmith" as awarded by ALOA

code n. a designation assigned to a particular key combination for reference when additional keys or cylinders may be needed. See also, "blind code", "direct code", and "key symbol"

code key n. a key cut to a specific code rather than duplicated from a pattern key. It may or may not conform to the lock manufacturer's specifications

code original key n. a code key which conforms to the lock manufacturer's specifications

combine v. to set a combination in a lock, cylinder, or key

combination n. the group of numbers which represent the biting of a key and/or the tumblers of a lock or cylinder

compensate drivers v. to select longer or shorter top pins, depending on the length of the rest of the pin stack, in order to achieve a uniform pin stack height

complementary keyway n. usually a disc tumbler keyway used in master keying. It accepts keys of different sections whose blades contact different bearing surfaces of the tumblers.

composite keyway n. a keyway which has been enlarged to accept more than one key section, often key sections of more than one manufacturer

compound bitted key n. a key with at least one compound cut

compound cut n. a biting which has another biting dimension within its dimensions

constant cut n. any biting(s) which are identical in corresponding positions from one key to another in a keying system. They usually serve to group these keys together within a given level of keying, and/or link them with keys of other levels. See also "rotating constant"

construction core n. an interchangeable or removable core designed for use during the construction phase of a building. The cores are normally keyed alike and, upon completion of construction, they are to be replaced by the permanent system's cores.

control chamber n. in an interchangeable or removable core, any chamber which has a control shear line, which is different from the operating shear line

control cut n. any biting which operates the retaining device of an interchangeable or removable core

control key n. 1. a key whose only purpose is to remove and/or install an interchangeable or removable core 2. a bypass key used to operate and/or reset some combination type locks 3. a key which allows disassembly of some removable cylinder locks

control lug n. that part of an interchangeable or removable core-retaining device which locks the core into its housing

control shear line n. the shear line which allows operation of the control lug of an interchangeable or removable core

control sleeve n. the part of an interchangeable or removable core retaining device which surrounds the plug

controlled cross keying a condition in which two or more different keys of the same level of keying and under the same higher level key(s) operate one cylinder by design; e.g., XAA1 operated by AA2 (but not XAA1 operated by AB1)
Note: This condition could severely limit the security of the cylinder and the maximum expansion of the system when (1) more than a few of these different keys operate a cylinder, or (2) more than a few differently cross keyed cylinders per system are required.

core n. a complete unit, often with a "figure eight" shape, which usually consists of the plug, shell, tumblers, springs, plug retainer and spring cover(s). It is primarily used in removable and interchangeable core cylinders and locks.

CPL abb. the title "Certified Professional Locksmith" as awarded by ALOA

CRL abb. the title "Certified Registered Locksmith" as awarded by ALOA

cross keying n. the deliberate process of combining a cylinder (usually in a master key system) to two or more different keys which would not normally be expected to operate it together. See also "controlled cross keying" and "uncontrolled cross keying."

cruciform adj. of or pertaining to a key section or keyway which usually resembles a plus sign (+) or the letter "X"

cut v. to make cuts into a key blade, see also "key cut(s)"

cut edge n. the portion of the key blade which contains the cuts

cut key n. a key which has been bitted or combined

cut root n. the bottom of a key cut

cut root shape n. the shape of the bottom of a key cut. It may have a flat or radius of a specific dimension, or be a perfect "V"

cutter n. the part of a key machine which makes the cuts into the key blank

cylinder n. a complete operating unit which usually consists of the plug shell, tumblers, springs, plug retainer, a cam/tailpiece or other actuating device, and all other necessary operating parts

cylinder blank n. a dummy cylinder which has a solid face and no operating parts

cylinder collar n. a plate or ring installed under the head of a cylinder to improve appearance and/or security

cylinder guard n. a protective cylinder mounting device

cylinder key n. a broad generic term including virtually all pin and disc tumbler keys

-D-

deadbolt n. a bolt, which requires a deliberate action to extend, and which resists end pressure in the unlocking direction when fully extended

deadlock n. a lock which incorporates a deadbolt

Terminology

deadlocking adj. pertaining to any feature which, when fully engaged, resists attempts to move the latch or bolt in the unlocking direction through direct pressure

declining step key n. a key whose outs are progressively deeper from bow to tip

decode v. to determine a key combination by physical measurement of a key and/or cylinder parts

decoder gauge n. a measuring device which helps determine the combination of a lock or cylinder without removing the tumblers

depth key set n. a set of keys used to make a code original key on a key duplicating machine to a lock manufacturer's given set of key bitting specifications. Each key is cut with the correct spacing to one depth only in all bitting positions, with one key for each depth.

derived series n. a series of blind codes and bittings which are directly related to those of another bitting list

direct code n. a designation assigned to a particular key which includes the actual combination of the key

disc tumbler n. 1. a flat tumbler which must be drawn into the cylinder plug by the proper key so that none of its extremities extends into the shell
2. a flat, usually rectangular tumbler with a gate which must be aligned with a sidebar by the proper key

double-acting lever tumbler n. one that must be lifted a precise amount, neither too little nor too much to allow movement of a bolt

double bitted key n. a key bitted on two opposite surfaces

double pin v. to place more than one master pin in a single pin chamber

drilled key n. a type of bit key with a hole drilled into the shank from the tip

driver spring n. a spring placed on top of the pin stack to exert pressure on the pin tumblers

drop n. a pivoting or swinging dust cover, see also "increment"

dummy cylinder n. a non-functional facsimile of a rim or mortise cylinder used for appearance only, usually to conceal a cylinder hole

duplicate v. to copy, see also "duplicate key"

duplicate key n. any key reproduced from a pattern key

dustproof cylinder n. a cylinder designed to prevent foreign matter from entering either end of the keyway

-E-

effective plug diameter n. the dimension obtained by adding the root depth of a key cut to the length of its corresponding bottom pin which establishes a perfect shear line. This will not necessarily be the same as the actual plug diameter.

ejector hole n. a hole found on the bottom of certain interchangeable cores under each pin chamber. It provides a path for the ejector pin.

ejector pin n. a tool used to drive all the elements of a pin chamber out of certain interchangeable cores

electrified lockset n. a lock which is controlled electrically

end ward n. a ward which prevents complete insertion and/or rotation of an incorrect key by forming an obstruction to the end of the key

end ward cut n. any cut made into a key to bypass an end ward

-F-

factory original key n. the out key furnished by the lock manufacturer for a lock or cylinder

fail-safe adj. a feature of a security device designed to release, for safety purposes, during a power loss

fence n. 1. a projection on a lock bolt which prevents movement of the bolt unless it can enter gates of properly aligned tumblers, see also "sidebar"
2. any locking element other than a sidebar or shackle designed to enter a tumbler's gate

file cabinet lock n. 1. any lock used on a file cabinet
2. a plunger lock cylinder for a gang lock normally used in a file cabinet

finish n. a material, coloring and/or texturing specification

first generation duplicate n. a key which was duplicated using a factory original key or a code original key as a pattern

first key n. any key produced without the use of a pattern key

five column progression n. a process wherein key bittings are obtained by using the cut possibilities in five columns of the key bitting array

five pin master key n. a master key for all combinations obtained by progressing five bitting positions

flat type key n. a key which is completely flat on both sides, usually used for warded or lever tumbler locks

flexible head mortise cylinder n. an adjustable mortise cylinder which can be extended against spring pressure to a slightly longer length

foot n. the cam portion of the trunnion assembly in some lever tumbler locks

four column progression n. a process wherein key bittings are obtained by using the cut possibilities in four columns of the key bitting array

four pin master key n. a master key for all combinations obtained by progressing four bitting positions

frangible shackle n. a padlock shackle designed to be broken easily

frangible shackle padlock n. a padlock equipped with an easily broken shackle

-G-

gate n. a notch cut into the edge of a tumbler to accept a fence or sidebar

GGGMK abb. great great grand master key

GGGMK'D abb. great great grand master keyed

GGM abb. great grand master key

GGMK abb. great grand master key

GGMK'D abb. great grand master keyed

GM abb. grand master key

GMK'D abb. grand master keyed

graduated drivers n. a set of top pins of different lengths. Usage is based on the height of the rest of the pin stack, in order to achieve a uniform pin stack height. See also "compensate drivers"

grand master key n. the key which operates two or more separate groups of locks, which are each operated by a different master key

grand master key system n. a master key system which has exactly three levels of keying

grand master keyed adj. of or pertaining to a lock or cylinder which is or is to be keyed into a grand master key system

great grand master key n. the key which operates two or more separate groups of locks which are each operated by a different grand master key

great grand master key system n. a master key system which has exactly four levels of keying

great grand master keyed adj. of or pertaining to a lock or cylinder which is or is to be keyed into a great grand master key system

great great grand master key n. the key which operates two or more separate groups of locks which are each operated by different great grand master keys

Terminology

great great grand master key system n. a master key system which has five or more levels of keying

great great grand master keyed adj. of or pertaining to a lock or cylinder which is or is to be keyed into a great great grand master key system

guide n. 1. that part of a key machine which follows the cuts of a pattern key or template during duplication 2. that part of a flat key lever lock which connects the nose to the foot and supports the key blade

-H-

hand change adj. pertaining to a combination lock in which the wheels must be removed in order to change the combination

handed adj. pertaining to hardware which is manufactured only for application on doors with a specific orientation

hardware schedule n. a listing of the door hardware used on a particular job it includes the types of hardware, manufacturers, locations, finishes, and sizes. It should include a keying schedule specifying how each locking device is to be keyed.

hasp n. a hinged metal strap designed to be passed over a staple and secured in place

heel & toe locking n. describes a padlock which has locking dogs at both the heel and toe of the shackle

heel (of a padlock shackle) n. the part of a padlock shackle which is retained in the case when in the unlocked position

HGM abb. horizontal group master key

high security cylinder n. a cylinder which offers a greater degree of resistance to any or all of the following: picking, impressioning, key duplication, drilling or other forms of forcible entry

high security key n. a key for a high security cylinder

hinged shackle n. a shackle whose heel is permanently mounted to the padlock case in a manner which allows the shackle to pivot to open

Hobbs shackle n. a hinged shackle with a notch for the bolt in its movable end

holding fixture n. a device which holds cylinder plugs, cylinders, housings, and/or cores to facilitate the installation of tumblers, springs and/or spring covers

hollow driver n. a top pin hollowed out on one end to receive the spring, typically used in cylinders with extremely limited clearance in the pin chambers

hook bolt n. a lock bolt shaped in the general outline of a hook. Normally used on sliding doors or where spreading of the frame and door is a possible attack.

horizontal group master key n. the two pin master key for all combinations listed in all blocks in a line across the page in the standard progression format

horn n. in a non-cylinder lock, the housing which surrounds the nose and extends through the door or drawer

horn plate n. the cover of a lever tumbler lock case to which the horn is attached

housing n. that part of a locking device which is designed to hold a core

hub n. a lock component, which redirects rotational motion from a spindle or shaft to linear movement of a latch or bolt

-I-

IC abb. interchangeable core

impression n. the mark made by a tumbler on its key cut v. to fit a key by the impression technique

impression technique n. a means of fitting a key directly to a locked cylinder by manipulating a blank in the keyway and cutting the blank where the tumblers have made marks

incidental master key n. a key cut to an unplanned shear line created when the cylinder is combined to the top master key and a change key

increment n. a usually uniform increase or decrease in the successive depths of a key cut which must be matched by a corresponding change in the tumblers

index (of a combination lock dial) n. the mark outside the dial ring of a combination lock used as a reference point

individual key n. an operating key for a lock or cylinder which is not part of a keying system, see also "change key" definition 1

interchangeable core n. a key removable core which can be used in all or most of the core manufacturer's product line. No tools (other than the control key) are required for removal of the core.

-K-

k sym. symbol for "keys" used after a numerical designation of the quantity of the keys requested to be supplied with the cylinders; e.g., 1k, 2k, 3k, etc. it is usually found in hardware/keying schedules.

KA abb. keyed alike

KA1, KA2, etc. symbol which indicates that all cylinders so designated are or are to be operated by the same key(s). The numerical designation indicates the keyed alike group or set.

KA/2, KA/3, etc. symbol used to indicate the quantity of locks or cylinders in keyed alike groups. These groups are usually formed from a larger quantity; e.g., 30 cylinders KA/2.

KBA abb. key biting array

KD abb. keyed different

key n. a properly combined device which is, or most closely resembles, the device specifically intended by the lock manufacturer to operate the corresponding lock

key biting array n. a matrix (graphic) display of all possible bittings for change keys and master keys as related to the top master key

key biting punch n. a manually operated device which stamps or punches the cuts into the key blade, rather than grinding or milling them

key biting specifications n. pl. the technical data required to bit a given (family of) key blank(s) to the lock manufacturer's dimensions

key blank n. any material manufactured to the proper size and configuration which allows its entry into the keyway of a specific locking device. A key blank has not yet been combined or cut.

key change adj. referring to a lock in which the combination can be changed through the use of a special key or tool without disassembling the lock

key changeable adj. of or pertaining to a lock or cylinder which can be recombined without disassembly, by the use of a key. The use of a tool may also be required.

key coding machine n. a key machine designed for the production of code keys. It may or may not also serve as a duplicating machine.

key control n. 1. any method or procedure which limits unauthorized acquisition of a key and/or controls distribution of authorized keys 2. a systematic organization of keys and key records

key cut(s) n. the portion of the key blade which remains after being cut and which aligns the tumbler(s)

key cut profile n. the shape of a key cut, including the cut angle and the out root shape

key duplicating machine n. a key machine which is designed to make copies from a pattern key

key gauge n. a usually flat device with a cutaway portion indexed with a given set of depth or spacing specifications. It is used to help determine the combination of a key.

key-in-knob cylinder n. a cylinder used in a key-in-knob lockset

key interchange n. an undesirable condition, usually in a master key system, whereby a key unintentionally operates a cylinder or lock

Terminology

key machine n. any machine designed to cut keys. See also "key coding machine" and "key duplicating machine."

key manipulation n. manipulation of an incorrect key in order to operate a lock or cylinder

key milling n. the grooves machined into the length of the key blade to allow its entry into the keyway

key override n. a provision allowing interruption or circumvention of normal operation of a combination lock or electrical device adj. of or pertaining to such a provision, as in "key override cylinder"

key override cylinder n. a lock cylinder installed in a device to provide a key override function

key pull(s) n. a lock specification which indicates by quantity and orientation the position(s) in which a key may be withdrawn

key pull position n. any position, of the cylinder plug at which the key can be removed

key records n. pl. records which typically include some or all of the following: biting list, key biting array, key system schematic, end user, number of keys/cylinders issued, names of persons to whom keys were issued, hardware/keying schedule

Key Records Department n. the department which is responsible for generating and issuing all lock and key combinations and maintaining records of them

key retaining adj. 1. of or pertaining to a lock which must be locked before its key can be removed. 2. of or pertaining to a cylinder or lock which may prevent removal of a key without the use of an additional key and/or tool

key section n. the exact cross sectional configuration of a key blade as viewed from the bow toward the tip

key symbol n. a designation used for a key combination in the standard key coding system, e.g., A, AA, AA1, etc.

key system schematic n. a drawing with blocks utilizing keying symbols, usually illustrating the hierarchy of all keys within a master key system. It indicates the structure and total expansion of the system.

keyed adj. 1. combined 2. having provision for operation by key

keyed alike adj. of or pertaining to two or more locks or cylinders which have or are to have the same combination. They may or may not be part of a keying system.

keyed different adj. of or pertaining to a group of locks or cylinders, each of which is or is to be combined differently from the others. They may or may not be part of a keying system.

keyed random adj. of or pertaining to a cylinder or group of cylinders selected from a limited inventory of different key changes. Duplicate bittings may occur.

keyhole n. the opening through which a non-cylinder key must pass to enter a lock

keying n. any specification for how a cylinder or group of cylinders are or are to be combined in order to control access

keying conference n. a meeting of the end user and the keying system supplier at which the keying and levels of keying, including future expansion, are determined and specified

keying kit n. a compartmented container which holds an assortment of tumblers, springs and/or other parts

keying schedule n. a detailed specification of the keying system listing how all cylinders are to be keyed and the quantities, markings, and shipping instructions of all keys and/or cylinders to be provided

keying symbol n. a designation used for a lock or cylinder combination in the standard key coding system; e.g., AA1, XAA1, XIX, etc.

keyway n. 1. the opening in a lock or cylinder which is shaped to accept key bit or blade of a proper configuration 2. the exact cross sectional configuration of a keyway as viewed from the front. It is not necessarily the same as the key section.

keyway ward n. a ward which prevents entry of an incorrect key into a cylinder or lock

KR abb. 1. keyed random 2. key retaining

KWY abb. keyway

-L-

laminated padlock n. a padlock whose case is constructed of separate plates usually riveted together

layout tray n. a compartmented container used to organize cylinder parts during keying or servicing

levels of keying n. pl. the divisions of a master key system into hierarchies of access, as shown in the following tables. Note: the standard key coding system has been expanded to include key symbols for systems of more than four levels of keying.

TWO LEVEL SYSTEM			
Level of Keying	Key Name	ABB.	Key Symbol
Level II	master key	MK	AA
Level I	change key	CK	1AA, 2AA, etc.

THREE LEVEL SYSTEM			
Level of Keying	Key Name	ABB.	Key Symbol
Level III	grand master key	GMK	A
Level II	master key	MK	AA, AB, etc.
Level I	change key	CK	AA1, AA2, etc.

FOUR LEVEL SYSTEM			
Level of Keying	Key Name	ABB.	Key Symbol
Level IV	great grand master key	GGMK	GGMK
Level III	grand master key	GMK	A, B, etc.
Level II	master key	MK	AA, AB, etc.
Level I	change key	CK	AA1, AA2, etc.

FIVE LEVEL SYSTEM			
Level of Keying	Key Name	ABB.	Key Symbol
Level V	great great grand master key	GGGMK	GGGMK
Level IV	great grand master key	GGMK	A, B, etc.
Level III	grand master key	GMK	AA, AB, etc.
Level II	master key	MK	AAA, AAB, etc.
Level I	change key	CK	AAA1, AAA2, etc.

SIX LEVEL SYSTEM			
Level of Keying	Key Name	ABB.	Key Symbol
Level VI	great great grand master key	GGGMK	GGGMK
Level V	great grand master key	GGMK	A, B, etc.
Level IV	grand master key	GMK	AA, AB, etc.
Level III	master key	MK	AAA, AAB, etc.
Level II	sub-master key	SMK	AAAA, AAAB, etc.
Level I	change key	CK	AAAA1, AAAA2, etc.

Terminology

lever pack n. a set of lever tumblers

lever tumbler n. a flat, spring-loaded tumbler which usually pivots on a post. It contains a gate which must be aligned with a fence to allow movement of the bolt.

loading tool n. a tool which aids installation of cylinder components into the cylinder shell

lock n. any device which prevents access or use by requiring special knowledge or equipment

lock bumping n. a picking technique that utilizes a bump key being forcefully impacted into the keyway

lock service package n. a kit offered by the manufacturer or distributor of a product, which contains what he deems required to properly service the product

locker lock n. a cabinet lock designed specifically for use on lockers

lockout n. any situation in which the normal operation of a lock or cylinder is prevented

lockout key n. a key made in two pieces. One piece is trapped in the keyway by the tumblers when inserted and blocks entry of any regular key. The second piece is used to remove the first piece.

locksmith n. a person with the knowledge and ability to select, install, service and bypass all the components of an electrical or mechanical lock

-M-

MACS abb. maximum adjacent cut specification

manipulation key n. any key other than a correct key which can be variably positioned and/or manipulated in a keyway to operate a lock or cylinder

master disc n. a special disc tumbler with multiple gates to receive a sidebar, see also "master pin" definition 1, see also "stepped tumbler".

master key n. a key which operates all the master keyed locks or cylinders in a group, each lock or cylinder usually operated by its own change key v. to combinate a group of locks or cylinders such that each is operated by its own change key as well as by a master key for the entire group

master key changes n. the number of different usable change keys available under a given master key

master key system n. 1. any keying arrangement which has two or more levels of keying 2. a keying arrangement which has exactly two levels of keying

master keyed adj. of or pertaining to a cylinder or group of cylinders which are or are to be combined so that all may be operated by their own change key(s) and by additional key(s) known as master key(s)

master keyed only adj. of or pertaining to a lock or cylinder which is or is to be combined only to a master key

master lever n. a lever tumbler which can align some or all other levers in its lock so that their gates are at the fence. It is typically used in locker locks.

master pin n. 1. usually a cylindrical shaped tumbler, flat on both ends, placed between the top and bottom pin to create an additional shear line 2. a pin tumbler with multiple gates to accept a sidebar

master wafer n. a ward used in certain binary type disc tumbler key-in-knob locks, see also "master pin" definition 1, see also "stepped tumbler"

matrix format master keying n. a method of generating combinations and assigning key symbols in a master key system through the use of a matrix

maximum adjacent cut specification n. the maximum allowable difference between adjacent cut depths

meter lock n. 1. a padlock whose shackle consists of a single removable post, designed for locking utility meters or valves. 2. any of several small devices specifically designed to lock utility meters or valves and which require either a key or special wrench for removal.

mis-cut adj. of or pertaining to a key which has been cut incorrectly n. a mis-cut key

MK abb. master key

MK'd abb. master keyed

MK'd only abb. master keyed only

mogul cylinder n. a very large pin tumbler cylinder whose pins, springs, key, etc. are also proportionally increased in size. It is frequently used in prison locks.

mortise cylinder n. a threaded cylinder typically used in mortise locks of American manufacture

multi-section key blank n. a key section which enters more than one, but not all keyways in a multiplex key system

multiple gating n. a means of master keying by providing a tumbler with more than one gate

multiplex key blank n. any key blank which is part of a multiplex key system

multiplex key system n. 1. a series of different key sections which may be used to expand a master key system by repeating bittings on additional key sections. The keys of one key section will not enter the keyway of another key section. This type of system always includes another key section which will enter more than one, or all of the keyways. 2. a keying system which uses such keyways and key sections

mushroom pin n. a pin tumbler, usually a top pin, which resembles a mushroom. It is typically used to increase pick resistance

-N-

NCK sym. symbol for "no change key," primarily used in hardware schedules

neck (of a key) n. 1. the portion of a bit key between the shoulder and the bit(s) 2. the portion of a cylinder key between the shoulder and the bow

negative locking n. locking achieved solely by spring pressure or gravity which prevents a key cut too deeply from operating a lock or cylinder

NKR abb. non key retaining

NMK sym. symbol which means "not master keyed" and is suffixed in parentheses to the regular key symbol. It indicates that the cylinder is not to be operated by the master key(s) specified in the regular key symbol; e.g., AB6(NMK).

non-fail safe adj. a feature of a security device designed to remain engaged, for security purposes, during a power loss

non key retaining adj. of or pertaining to a lock whose key can be removed in both the locked and unlocked positions

non-original key blank n. any key blank other than an original

non removable key adj. a key which has one or more cuts on it which trap the key in the lock upon insertion

nose n. the part of a non-cylinder lock which contains the keyway and rotates within a horn

NRK abb. non removable key

NRP abb. non removable pin

-O-

odometer method n. a means of progressing key bittings using a progression sequence of right to left.

one bitted adj. of or pertaining to a cylinder which is or is to be combined to keys cut to the manufacturer's reference number one bitting

one column progression n. a process wherein key bittings are obtained by using the cut possibilities in one column of the key bitting array

one pin master key n. a master key for all combinations obtained by progressing only one bitting position

open gated adj. pertaining to a lever tumbler whose gate is in the edge of the tumbler

opening index n. the index or mark to which a combination is dialed in order to effect an opening

operating key n. any key which will properly operate a lock or cylinder to lock or unlock the lock mechanism and is not a control key or reset key, see also "change key"

Terminology

operating shear line n. any shear line which allows normal operation of a cylinder or lock

original key blank n. a key blank supplied by the lock manufacturer to fit that manufacturer's specific product

-P-

pack n. the set of tumblers in a lever tumbler or combination lock

padlock n. a detachable and portable lock with a shackle which locks into its case

page master key n. the three-pin master key for all combinations listed on a page in the standard progression format

paracentric adj. 1. of or pertaining to a keyway with one or more wards on each side projecting beyond the vertical center line of the keyway to hinder picking 2. of or pertaining to a key blank made to enter such a keyway

pattern key n. 1. an original key kept on file to use in a key-duplicating machine when additional keys are required 2. any key which is used in a key-duplicating machine to create a duplicate key

personal identification number n. a series of numbers and/or letters associated with a particular individual as a means of identification

pick n. a tool or instrument, other than the specifically designed key, made for the purpose of manipulating tumblers in a lock or cylinder into the locked or unlocked position through the keyway, without obvious damage. v. to manipulate tumblers in a keyed lock mechanism through the keyway, without obvious damage, by means other than the specifically designed key

pick key n. a type of manipulation key, cut or modified to operate a lock or cylinder

pin v. to install pin tumblers into a cylinder and/or cylinder plug, see also "pin tumbler"

PIN abb. personal identification number

pin chamber n. the corresponding hole drilled into the cylinder shell and/or plug to accept the pin(s) and spring

pin kit n. a type of keying kit for a pin tumbler mechanism

pin stack n. all the tumblers in a given pin chamber, see also "pin stack height"

pin stack height n. the measurement of a pin stack, often expressed in units of the lock manufacturer's increment or as an actual dimension

pin tray n. see "layout tray"

pin tumbler n. usually a cylindrical shaped tumbler. Three types are normally used: bottom pin, master pin and top pin.

pin tweezers n. pl. a tool used in handling tumblers and springs

pinning block n. a holding fixture which assists in the loading of tumblers into a cylinder or cylinder plug

pinning chart n. a numerical diagram which indicates the sizes and order of installation of the various pins into a cylinder. The sizes are usually indicated by a manufacturer's reference number which equals the quantity of increments a tumbler represents.

plug n. the part of a cylinder which contains the keyway, with tumbler chambers usually corresponding to those in the cylinder shell

plug follower n. a tool used to allow removal of the cylinder plug while retaining the top pins, springs, and/or other components within the shell

plug holder n. a holding fixture which assists in the loading of tumblers into a cylinder plug

plug retainer n. the cylinder component which secures the plug in the shell

positive locking n. the condition brought about when a key cut which is too high forces its tumbler into the locking position. This type of locking does not rely on gravity or spring pressure.

post (of a key) n. the portion of a bit key between the tip and the shoulder, to which the bit(s) is attached

practical key changes n. pl. the total number of usable different combinations available for a specific cylinder or lock mechanism

privacy key n. a key which operates an SKD cylinder, see also "emergency key"

profile cylinder n. a cylinder with a usually uniform cross section, which slides into place and usually is held by a mounting screw. It is typically used in mortise locks of non-U.S. manufacture.

progress v. to select possible key bittings, usually in numerical order, from the key bitting array

progression n. a logical sequence of selecting possible key bittings, usually in numerical order from the key bitting array

progression column n. a listing of the key bitting possibilities available in one bitting position as displayed in a column of the key bitting array

progression list n. a bitting list of change keys and master keys arranged in sequence of progression

progressive n. any bitting position which is progressed rather than held constant

proprietary adj. of or pertaining to a keyway and key section assigned exclusively to one end user by the lock manufacturer. It may also be protected by law from duplication.

pull bump key n. a lock picking key that must be pulled from the lock one space position between impacts

push bump key n. a lock picking key that centers itself after each impact

-R-

radiused blade bottom n. the bottom of a key blade which has been radiused to conform to the curvature of the cylinder plug it is designed to enter

random master keying n. any undesirable process used to master key which uses unrelated keys to create a system

rap v. 1. to unlock a plug from its shell by striking sharp blows to the spring side of the cylinder while applying tension to the plug 2. to unlock a padlock shackle from its case by striking sharp blows to the sides in order to disengage the locking dogs

ratchet lock n. any lock which incorporates a ratchet device allowing locking in more than one position

read v. to decode a lock combination visually without disassembly of the lock or cylinder

recombine v. to change the combination of a lock, cylinder or key

recore v. to rekey by installing a different core

register groove n. the reference point on the key blade from which some manufacturers index the bitting depths

rekey v. to change the existing combination of a cylinder or lock

removable cylinder n. a cylinder which can be removed from a locking device by a key and/or tool

removable shackle adj. referring to a type of padlock which is unlocked by removing the shackle from the case

repin v. to replace pin tumblers, with or without changing the existing combination

restricted adj. of or pertaining to a keyway and corresponding key blank whose sale and/or distribution is limited by the lock manufacturer in order to reduce unauthorized key proliferation

retainer n. a component which is clipped or staked in place to maintain the working relationship of other components

RH abb. right hand

RHR abb. right hand reverse bevel

rim cylinder n. a cylinder typically used with surface applied locks and attached with a back plate and machine screws. It has a tailpiece to actuate the lock mechanism.

Terminology

rim lock n. a lock or latch typically mounted on the surface of a door or drawer

RL abb. The title "Registered Locksmith" as awarded by ALOA

RM abb. row master key

root depth n. the dimension from the bottom of a cut on a key to the bottom of the blade

rotating constant n. one or more cut(s) in a key of any level which remain constant throughout all levels and are identical to the top master key cuts in their corresponding positions. The positions where the top master key cuts are held constant may be moved, always in a logical sequence.

rotating constant method n. a method used to progress key bittings in a master key system, wherein at least one cut in each key is identical to the corresponding cut in the top master key. The identical cut(s) is moved to different locations in a logical sequence until each possible planned position has been used.

row master key n. the one-pin master key for all combinations listed on the same line across a page in the standard progression format

-S-

S/A abb. sub-assembled

Scandinavian padlock n. a cast case padlock with an elliptical cross section. The locking mechanism is a set of rotating disc tumblers, which engage notches in the cast shackle and may be rotated by the angled cuts cast on the key.

screen door lock n. a lock designed for the thin stiles typically found on screen and storm doors

second generation duplicate n. a key reproduced from a first generation duplicate

security collar n. a protective cylinder collar, see also "cylinder guard"

selective key system n. a key system in which every key has the capability of being a master key. It is normally used for applications requiring a limited number of keys and extensive cross keying.

selective master key n. an unassociated master key which can be made to operate any specific lock(s) in the entire system in addition to the regular master key(s) and/or change key(s) for the cylinder without creating key interchange

sequence of progression n. the order in which bitting positions are progressed to obtain change key combinations

seven column progression n. a process wherein key bittings are obtained by using the cut possibilities in seven columns of the key bitting array

seven pin master key n. a master key for all combinations obtained by progressing seven bitting positions

shackle n. 1. the part of a padlock, which passes through an opening in an object or fits around an object and is ultimately locked into the case
2. the portion of a restraint which fits around the wrist, ankle, neck, waist or thumb

shackle retaining pin n. a pin which keeps an unlocked shackle heel in the case

shackle spring n. a spring which pushes the shackle into the open position when the padlock is unlocked

shear line n. a location in a cylinder at which specific tumbler surfaces must be aligned, removing obstruction(s) which prevented the plug from moving

shell n. the part of the cylinder which surrounds the plug and which usually contains tumbler chambers corresponding to those in the plug

shim n. a thin piece of material used to unlock the cylinder plug from the shell by separating the pin tumblers at the shear line, one at a time v. to unlock a cylinder plug from its shell by using a shim

shoulder n. any key stop other than a tip stop, see also "bow stop"

shove knife n. a tool used with a set-up plug which pushes the springs and pin tumblers into the cylinder shell

shrouded shackle n. a shackle which is protected from cutting or tampering by design or by the use of secondary shields

sidebar n. a cylinder component which enters gate(s) in tumbler(s) to allow plug rotation

sidebar lock n. a lock mechanism which incorporates a sidebar

simplex key section n. a single independent key section which cannot be used in a multiplex key system

single-acting lever tumbler n. a lever tumbler which must be moved a minimum distance to allow travel of a bolt, but cannot be moved so far as to restrict travel of the bolt

single key section n. an individual key section which can be used in a multiplex key system

single step progression n. a progression using a one increment difference between bittings of a given position

six column progression n. a process wherein key bittings are obtained by using the cut possibilities in six columns of the key bitting array

six pin master key n. a master key for all combinations obtained by progressing six bitting positions

SKD sym. symbol for "single keyed", normally followed by a numerical designation in the standard key coding system; e.g., SKD1, SKD2, etc. It indicates that a cylinder or lock is not master keyed but is part of the keying system

SMK abb. sub-master key

spacing n. the dimensions from the stop to the center of the first cut and/or to the centers of successive cuts

spindle n. a component which transfers rotary motion from outside a lock or latch case to an inner mechanism

split pin master keying n. a method of master keying a pin tumbler cylinder by installing master pins into one or more pin chambers

spool pin n. usually a top pin which resembles a spool, typically used to increase pick resistance

spring cover n. a device for sealing one or more pin chambers

spring seat n. the point at which a spring is anchored, located or attached and at which (from which) it exerts force

standard key coding system n. an industry standard and uniform method of designating all keys and/or cylinders in a master key system. The designation automatically indicates the exact function and keying level of each key and/or cylinder in the system, usually without further explanation.

standard progression format n. a systematic method of listing and relating all change key combinations to all master key combinations in a master key system. The listing is divided into segments known as blocks, horizontal groups, vertical groups, rows, and pages, for levels of control.

stepped tumbler n. a special (usually disc) tumbler used in master keying. It has multiple bearing surfaces for blades of different key sections.

stop (of a key) n. the part of a key from which all cuts are indexed and which determines how far the key enters the keyway

sub-master key n. the master key level immediately below the master key in a system of six or more levels of keying

substitution code n. a code whose individual characters are converted to individual key cuts or combination numbers by means of a reference table

-T-

T-handle n. a T-shaped handle assembly which may be lockable

tailpiece n. an actuator attached to the rear of the cylinder, parallel to the plug, typically used on rim, key-in-knob or special application cylinders

Terminology

theoretical key changes n. pl. the total possible number of different combinations available for a specific cylinder or lock mechanism

three column progression n. a process wherein key bittings are obtained by using the cut possibilities in three columns of the key bitting array

three pin master key n. a master key for all combinations obtained by progressing three bitting positions

three point latch n. a self-latching device designed to latch a door at the top, bottom and edge

throw member n. an intermediate actuator which engages the rear of the plug to transfer motion to a cam, tailpiece or other actuator

tip n. the portion of the key which enters the keyway first

tip stop n. a type of stop located at or near the tip of the key

TMK abb. top master key

toe (of a shackle) n. that part of the shackle, which may be removed from the padlock body

tolerance n. the deviation allowed from a given dimension

top master key n. the highest level master key in a master key system

top of blade n. the bitted edge of a single bitted key

top pin n. usually a cylindrical shaped tumbler, usually flat on both ends and installed directly under the spring in the pin stack

total position progression n. a process used to obtain key bittings in a master key system wherein bittings of change keys differ from those of the top master key in all bitting positions

try-out key n. a manipulation key which is usually part of a set, used for a specific series, keyway, and/or brand of lock

tubular key n. a key with a tubular blade. The key cuts are made into the end of the blade, around its circumference.

tubular key cylinder n. a cylinder whose tumblers are arranged in a circle and which is operated by a tubular key

tumbler n. a movable obstruction of varying size and configuration in a lock or cylinder which makes direct contact with the key or another tumbler and prevents an incorrect key or torque device from activating the lock or other mechanism

tumbler spring n. any spring which acts directly on a tumbler

two column progression n. a process wherein key bittings are obtained by using the cut possibilities in two columns of the key bitting array

two pin master key n. a master key for all combinations obtained by progressing two bitting positions

two-step progression n. a progression using a two increment difference between bittings of a given position

-U-

UL abb. Underwriters Laboratories

UL listed adj. listed in a directory as having passed specific Underwriters Laboratories testing

unassociated change key n. a change key which is not related directly to a particular master key through the use of certain constant cuts

unassociated master key n. a master key which does not have change keys related to its combination through the use of constant cuts

uncombined adj. 1. of or pertaining to a cylinder which is or is to be supplied without keys, tumblers and springs 2. of or pertaining to a lock, cylinder or key in which the combination has not been set

uncontrolled cross keying n. a condition in which two or more different keys under different higher level keys operate one cylinder by design; e.g., XAA1 operated by AB, AB1. Note: This condition severely limits the security of the cylinder and the maximum expansion of the system, and often leads to key interchange.

unidirectional cylinder n. a cylinder whose key can turn in only one direction from the key pull position

-V-

vertical group master key n. the two-pin master key for all combinations listed in all blocks in a line down a page in the standard progression format

VGM abb. vertical group master key

visual key control n. a specification that all keys and the visible portion of the front of all lock cylinders be stamped with standard keying symbols

VKC abb. visual key control

virtual key section n. a secondary locking mechanism combination used as a method of discriminating between suppliers for key control

-W-

ward n. a usually stationary obstruction in a lock or cylinder which prevents the entry and/or operation of an incorrect key

ward cut n. a modification of a key which allows it to bypass a ward

warded adj. having one or more wards

-X-

X sym. symbol used in hardware schedules to indicate a cross-keyed condition for a particular cylinder; e.g., XAA2, XIX (but not AX7)

-Z-

zero bitted adj. of or pertaining to a cylinder which is or is to be combined to keys cut to the manufacturer's reference number "0" bitting

Make To Order Capability

Security Products Built and Keyed to Your Requirements Within 5 Days

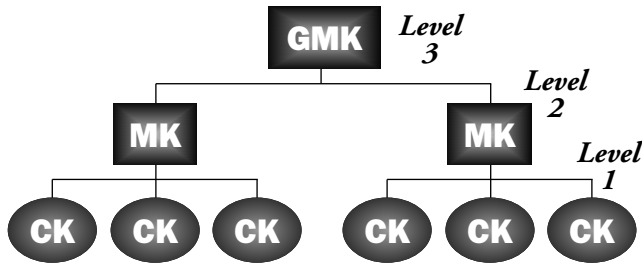

Choose Keying – KD, KA, MK, GMK.
Over 60 Keyways Available



Choose Custom Marking

Choose Extra-Length Shackles



Custom Marking

Laser Engraving, Hard Stamping and Pad Printing



Merchandising Displays & Service Parts

Support for dealers



Locksmith Training

Technical and servicing product information to best serve your customers

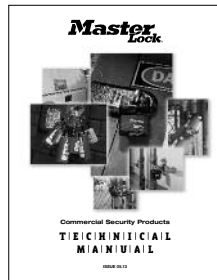

Key Charting Service

Maintain records of registered end users to ensure system integrity

Customer Service & Sales Support

Over 75 dedicated and knowledgeable employees ready to serve you



Online Resources

PRODUCT INFORMATION:
www.masterlock.com
ONLINE ORDERING:
www.masterlockshop.com
ORDER TRACKING:
www.masterease.com
IMAGE LIBRARY
www.masterlockimages.com



www.masterlock.com

Master Lock Company LLC, Milwaukee, WI 53154 U.S.A. | 800-308-9244
Master Lock Canada, Oakville, Ontario L6H 5S7 Canada | 800-227-9599
© 2013 Master Lock Company LLC | All Rights Reserved

7000-0031

CI 2.5M Printed in U.S.A. 6/13 E-Rev 9/13

